

CASABLANCA<sup>®</sup>  
FAN COMPANY



CASABLANCA FAN COMPANY

CRAFTED TO PERFECTION 2016



7130 Goodlett Farms Pkwy., Suite 400

Memphis, TN 38016

1.888.227.2178

[www.casablancafanco.com](http://www.casablancafanco.com)



## INSPIRED BY THE WORLD AROUND US. CRAFTED FOR YOUR LIVING ROOM.

We've never been ones to blindly follow the latest trends. We prefer to explore, imagine, lead, and set the trends ourselves. Our world-class designers stay away from the safe confines of the status quo, seeking inspiration in the world around them. As we begin to turn that inspiration into something beautiful and exquisite, we don't use computers or restrictive templates. Each design is hand-sketched to capture every painstaking detail of our vision.

After inspiration finds its way onto paper, we build the fan ourselves to guarantee every aspect of the fan is crafted to perfection. We guide the entire process by assuring that each model lives up to our reputation of breathtaking design, highest quality materials, innovative engineering, and flawless functionality. Then, we put each fan through the most rigorous testing in the industry. The result is a fan that is not just a fan, but it is a conversation generating centerpiece for any room in your home.



DOWNLOAD OUR NEW VISUALIZER APP  
TO SEE CASABLANCA FANS IN YOUR SPACE



# WHY CASABLANCA IS THE WORLD'S FINEST CEILING FAN.

## INSPIRED DESIGN

Our designers put their stamp on each fan by taking inspiration from the world's most celebrated architecture. Designs are hand-sketched to give every model an organic look that our artisans bring to life.

## METICULOUS DETAILS

From premium materials and ornate design to seamless transitions and hidden hardware, we fret over each and every detail to deliver your home's newest masterpiece.

## CUSTOM BEAUTY

By having a wide variety of blade styles that are compatible with all Custom Casablanca fans, we make it easier than ever to add your very own personal touch. With a streamlined offering of light fixtures, you'll find the perfect lighting option to complement your style and taste.

## RIGOROUS TESTING

We hold ourselves to a much higher standard than the industry does. We hold ourselves to higher-than-industry standards by performing a 20,000 repetition shake test, a drop test that is six inches higher than regulation, UV chamber testing, and randomized quality assurance tests. These are just a few of the ways we stand above the competition to assure your fan will last.

## THE VERY BEST MOTORS

Engineered to work flawlessly over the life of your fan, our high-end motors are ENERGY STAR® certified and are at the top of their class in air movement while being the industry's most quiet designs.

## INNOVATIVE CONTROLS

Highly advanced yet simple to use, our all-in-one controls make it easy to get the most out of your Casablanca ceiling fan.

# DESIGNED FOR YOU AND THE WORLD YOU LIVE IN.



Seeking excellence doesn't stop with design and engineering. We put thousands of hours into developing a fan that's more efficient, so you can feel good about your energy savings and your contribution to the environment. Casablanca motors move more cubic feet of air per minute (CFM) while using significantly less energy. Fan blades are set at the optimum pitch to deliver maximum airflow at any speed. Even at the highest setting, each fan uses about the same amount of power as a 100-watt lightbulb.



Most of our new fans are ENERGY STAR® certified along with many that were already part of the Casablanca collection. This means they provide even greater energy efficiency. Look for the ENERGY STAR logo throughout the catalog. Specific fan models are equipped with highly efficient LEDs, and are California 20 compliant for maximum energy savings.

To simplify things, we've included this informational energy chart for every fan:

Airflow:	Electricity Use:	Airflow Efficiency:
X,XXX <sub>cfm</sub>	XX <sub>w</sub>	XX <sub>cfm/w</sub>

*38" to 48" ceiling fans have airflow efficiencies ranging from approximately 71 to 86 cubic feet per minute per watt at high speed.*

*49" to 60" ceiling fans have airflow efficiencies ranging from approximately 51 to 176 cubic feet per minute per watt at high speed.*

CONSERVATION TIP: Operating a fan in an unoccupied room wastes energy, so turn it off when leaving the room.



#### QUALITY CRAFTSMANSHIP BACKED BY 120-DAY IN-HOME SERVICE

Our attention to detail continues past the design and creation of our fans. Should you have any concerns with your Casablanca fan, a trained representative will be sent to your home to service it. Simply call us at 1-888-227-2178 for a referral to your local Authorized Service Center. If In-Home Service is not available in your area, Casablanca offers pre-paid freight for you to send the fan to the Casablanca Factory Service Center. It will be repaired and returned to you at no charge.

Casablanca's Comprehensive Warranty, the most extensive in the industry, also includes:

#### LIFETIME MOTOR WARRANTY

All Casablanca fan motors, even Damp- and Wet-rated models, are guaranteed for life.

#### ONE-YEAR PARTS AND ELECTRONICS WARRANTY

Each fan includes a one-year warranty on finish, component parts, accessories, and electronics.

With this extensive coverage, you can enjoy the beauty, quality, and performance of your Casablanca products for decades to come.















Featuring 120-Day In-Home Service

CUSTOM CASABLANCA

			
54" - 60" ACADEMY - 17	54" - 60" ADELAIDE - 18	54" - 60" ARETO - 19	54" - 60" BRESCIA CONTROL - 20
			
54" - 60" BRESCIA PULLCHAIN - 21	54" - 60" CAPISTRANO - 22	54" - 60" CHARHOUSE - 23	54" - 60" COLETTI - 24
			
54" - 60" COMPASS POINT - 25	54" - 60" CRESTMONT - 26	54" - 60" HOLLISTON - 27	52" - 58" PANAMA CONTROL - 28
			
52" - 58" PANAMA PULLCHAIN - 29	52" - 58" PANAMA XLP CONTROL - 30		

TRADITIONAL

			
54" AINSWORTH - 33	60" AINSWORTH - 34	54" AINSWORTH GALLERY - 35	60" AINSWORTH GALLERY - 36
			
52" CAPISTRANO GALLERY - 37	54" CONCENTRA - 38	54" CONCENTRA GALLERY - 39	44" FORDHAM - 40
			
54" PANAMA DC - 41	54" PANAMA GALLERY - 42	54" VICTORIAN - 43	31" WAILEA - 44



TRANSITIONAL

 54" ACADEMY GALLERY – 47	 68" ATRIA – 48	 56" BEL AIR – 49	 56" CANEEL BAY – 50
 60" FELLINI – 51	 66" FELLINI DC – 52	 56" GLEN ARBOR – 53 <b>NEW</b>	 60" HEATHRIDGE – 55
 60" HERITAGE – 56	 60" HOLLISTON GALLERY – 57	 52" UTOPIAN – 58	 52" UTOPIAN GALLERY – 59
 54" WHITMAN – 60			



CONTEMPORARY

 54" ARIS – 63	 54" BULLET – 64	 56" CORRENE – 65 <b>NEW</b>	 60" DULUTH – 67 <b>NEW</b>
 72" DULUTH – 68 <b>NEW</b>	 30" ORCHID – 69 <b>NEW</b>	 64" PERSEUS – 71 <b>NEW</b>	 52" PISTON – 73 <b>NEW</b>
 60" RIELLO – 75	 54" STEALTH – 76	 54" STEALTH DC – 77	 54" STEALTH DC LED – 78
 60" STINGRAY – 79 <b>NEW</b>	 52" TERCERA – 81	 52" TRIBECA – 82	 60" TRIBECA – 83











CONTEMPORARY









 54" TRIDENT – 84	 44" VERSE – 85	 54" VERSE – 86	 44" WISP – 87 <b>NEW</b>
 52" WISP – 89 <b>NEW</b>	 56" ZUDIO – 90		

LOW PROFILE

 54" CALEDONIA – 93	 44" DURANT – 94	 54" DURANT – 95	 54" DURANT – 96
 44" ISOTOPE – 97	 52" ISOTOPE – 98	 44" VERSE – 99	 54" VERSE – 100

OUTDOOR

 54" ARIS – 103	 68" ATRIA – 104	 56" CANEEL BAY – 105	 54"-60" CAPISTRANO – 106
 54"-60" CHARTHOUSE – 107	 54"-60" COMPASS POINT – 108	 54"-60" CRESTMONT – 109	 60" DULUTH – 110 <b>NEW</b>
 72" DULUTH – 111 <b>NEW</b>	 60" HEATHRIDGE – 113	 60" HERITAGE – 114	 30" ORCHID – 115 <b>NEW</b>

OUTDOOR			
 52"-58" PANAMA CONTROL – 116	 52"-58" PANAMA PULLCHAIN – 117	 64" PERSEUS – 118 <b>NEW</b>	 52" PISTON – 119 <b>NEW</b>
 52" UTOPIAN – 120	 52" UTOPIAN GALLERY – 121	 44" VERSE – 122	 54" VERSE – 123
 31" WAILEA – 124			

ACCESSORIES - SPECIFICATIONS - INDEXES

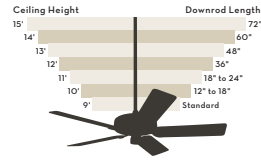
 LIGHTING – 127 - 130	 LIGHTING COMPATIBILITY – 131-132	 HANGING SYSTEM – 133	 CONTROLS – 134
--	--	---	--

CEILING FAN SPECIFICATIONS 135 - 138  
 MOTOR FINISHES - 139  
 NUMERICAL AND ALPHABETICAL INDEXES - 140

ICON LEGEND

SPECIAL FEATURES



INCLUDES XLP MOTOR



ETL WET RATED FAN



INCLUDES DC MOTOR



ETL DAMP RATED FAN



ENERGY STAR® CERTIFIED



CUSTOM CASABLANCA

BLADES



INCLUDES DOWNLIGHT

LIGHTING



INCLUDES DOWNLIGHT



INCLUDES UPLIGHT OR ACCENT LIGHT



INCLUDES LED LIGHT

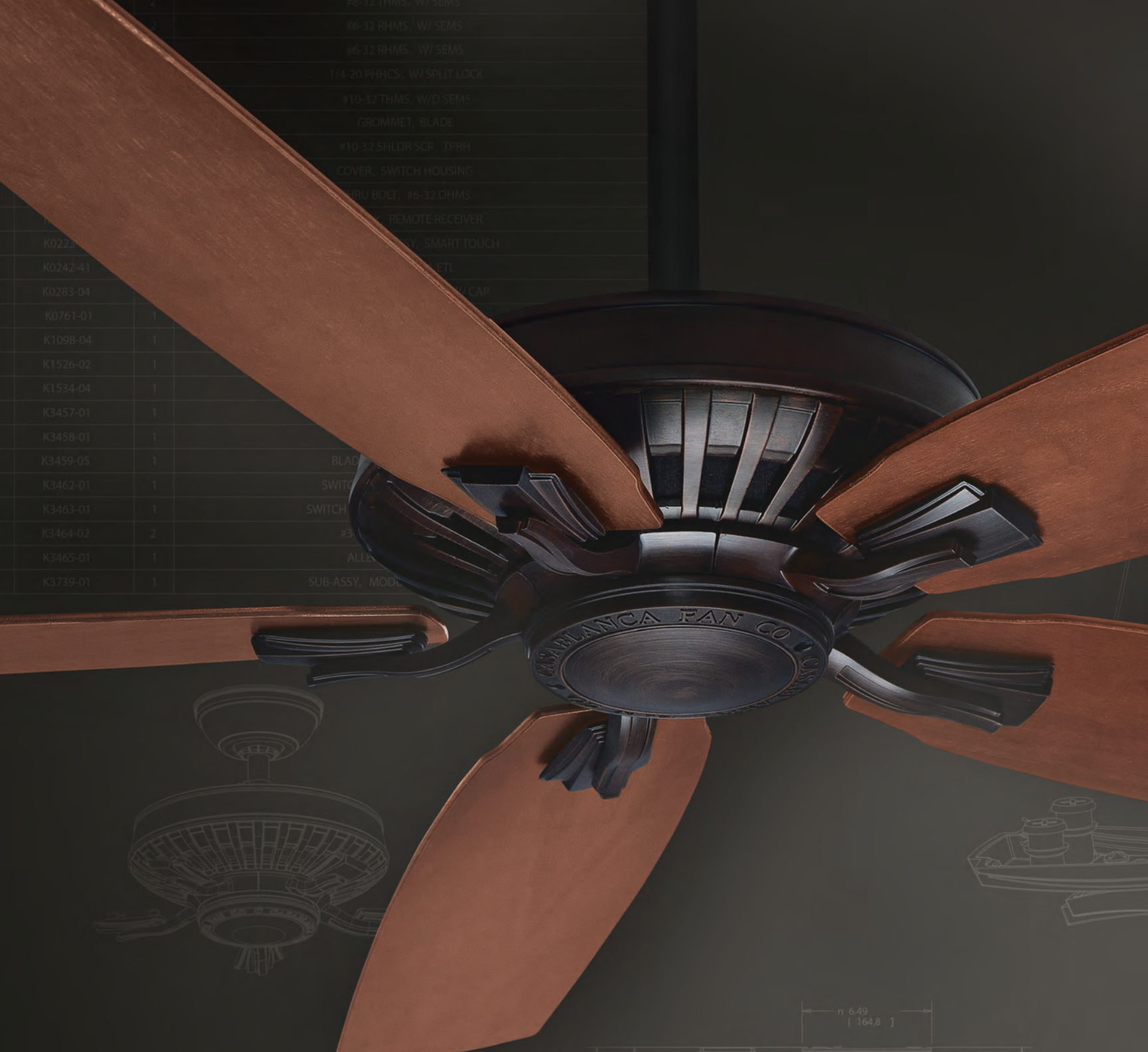

K0223		
K0242-41		
K0283-04		
K0761-01	1	
K1098-04	1	
K1526-02	1	
K1534-04	1	
K3457-01	1	
K3458-01	1	
K3459-05	1	
K3462-01	1	
K3463-01	1	
K3464-02	2	
K3465-01	1	
K3739-01	1	

#6-32 THMS, W/ SEMS  
 #6-32 RHMS, W/ SEMS  
 #6-32 RHMS, W/ SEMS  
 1/4-20 PPHCS, W/ SPLIT LOCK  
 #10-32 THMS, W/O SEMS  
 GROMMET, BLADE  
 #10-32 SHLDR SCR, TPRH  
 COVER, SWITCH HOUSING  
 SCREW BOLT, #6-32 OHMS  
 REMOTE RECEIVER  
 SMART TOUCH  
 FTL  
 CAP  
 BLAD  
 SWITCH  
 SWITCH  
 #3  
 ALLE  
 SUB-ASSY, MOD

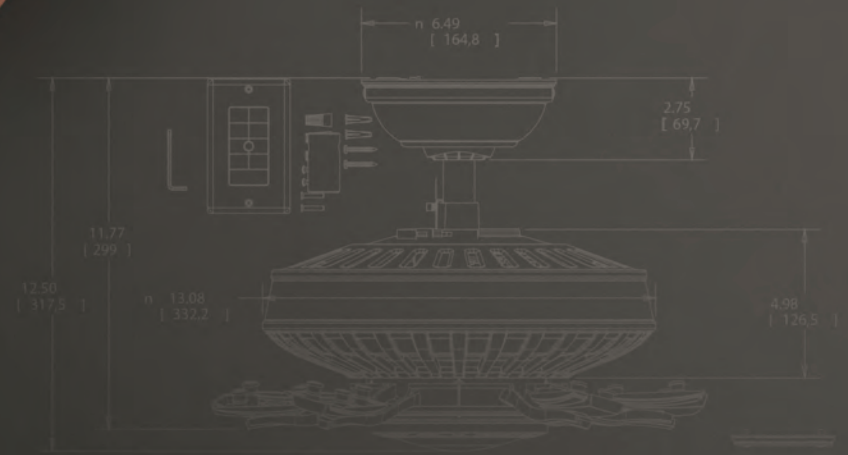
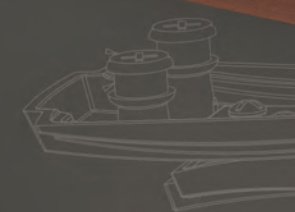

CRESTMONT CEILING FAN



# CUSTOM CASABLANCA

# DESIGN YOUR CUSTOM FAN

## 1 STEP

### DETERMINE IF YOUR FAN IS FOR INDOOR OR OUTDOOR USE

Any Casablanca fan can be installed indoors, but look for the wet and damp icons to quickly see if the fan is also rated for outdoor use.

## 2 STEP

### SELECT YOUR MOTOR DESIGN AND FINISH

Each collection page shows available motor styles and finishes.

## 3 STEP

### CHOOSE YOUR BLADE FINISH AND SHAPE

The foldout on page 15 will serve as an easy side-by-side reference to help you select the perfect blade set for your fan.

## 4 STEP

### SELECT YOUR LIGHT FIXTURE AND GLASS

Look for our design team's lighting recommendation for each collection, or choose from all available options shown on pages 127-130.

## 5 STEP

### DECIDE IF YOU NEED AN ACCESSORY CONTROL

Every fan comes with either a wall control or 4-speed pullchain, but you can choose to add an optional remote control.

Design your custom fan online at [www.customcasablanca.com](http://www.customcasablanca.com)



1

2

3

4

5

# BLADES

*any style*

CHOOSE YOUR BLADE INSIDE





INDOOR BLADES



99001 - Matte Snow White / Cottage White, 52"-54" Blade Span



99002 - Burnt Walnut / Walnut Veneer, 52"-54" Blade Span



99003 - Wine Country Distressed / Vintage Rosewood Distressed Veneer, 52"-54" Blade Span



99004 - Burnt Walnut / Walnut Veneer, 58"-60" Blade Span



99005 - Matte Snow White / Cottage White, 52"-54" Blade Span



99006 - Burnt Walnut/Walnut Veneer, 52"-54" Blade Span



99007 - Espresso/Smoked Walnut Veneer, 52"-54" Blade Span



99008 - Matte Snow White / Cottage White, 58"-60" Blade Span



99009 - Burnt Walnut / Walnut Veneer, 58"-60" Blade Span



99010 - Walnut Carved Wood, 52"-54" Blade Span



99011 - Blackened Pecan Carved Wood, 52"-54" Blade Span



99024 - Blackened Pecan Carved Wood, 58"-60" Blade Span



99174 - High-Gloss Snow White, 52"-54" Blade Span



99175 - Light Walnut Veneer, 52"-54" Blade Span



99176 - Gray Washed Veneer, 52"-54" Blade Span



99177 - Mountain Timber, 52"-54" Blade Span



99178 - River Timber / White Washed Distressed Oak Veneer, 52"-54" Blade Span

OUTDOOR BLADES

99012  
Matte Snow White  
All-Weather,  
52"-54" Blade Span



99013  
Black Mahogany  
All-Weather,  
52"-54" Blade Span



99014  
Cottage White  
Beadboard  
All-Weather,  
52"-54" Blade Span



99015  
Distressed Antique  
Halifax All-Weather,  
52"-54" Blade Span



99016  
Plantation Wicker  
All-Weather,  
52"-54" Blade Span



99046  
Blackened Pecan  
Carved Wood  
All-Weather,  
54"-56" Blade Span



99047  
Walnut Carved Wood  
All-Weather,  
58"-60" Blade Span



99017  
Cottage White  
All-Weather,  
58"-60" Blade Span



99018  
Espresso  
All-Weather,  
58"-60" Blade Span



99021  
Matte Snow White  
All-Weather,  
52"-54" Blade Span

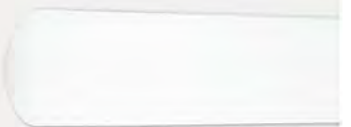

99022  
Cocoa All-Weather,  
52"-54" Blade Span



# DESIGNER RECOMMENDATION GUIDE

Because we've simplified our fan blades by creating one universal hole pattern, most blade styles now work on most new fan bodies. Here are our design team's recommended blade pairings to help you build your ideal fan with classic Casablanca style.

- Blades suitable for Indoor Use only
- \* All-Weather ABS Blades designed for use in any environment—indoors or out. For use outdoors, fan must be Damp or Wet Listed

Blades		Academy	Adelaide	Areto	Brescia	Brescia Pullchain	Capistrano	Charthouse	Coletti	Compass Point	Crestmont	Holliston	Panama Control	Panama Pullchain	Panama XLP
99001	 Matte Snow White / Cottage White (52"-54")	●	●	●	●	●	●	●	●	●	●	●	●	●	●
99002	 Burnt Walnut / Walnut Veneer (52"-54")	●		●			●	●	●	●	●	●	●	●	●
99003	 Wine Country Distressed / Vintage Rosewood Distressed Veneer (52"-54")	●	●	●	●	●	●	●	●	●	●	●	●	●	●
99004	 Burnt Walnut / Walnut Veneer (58"-60")	●	●	●	●	●	●	●	●	●	●	●	●	●	●
99005	 Matte Snow White / Cottage White (52"-54")	●	●	●			●	●	●	●	●	●	●	●	●
99006	 Burnt Walnut / Walnut Veneer (52"-54")	●	●	●	●	●	●	●	●	●	●	●	●	●	●
99007	 Espresso/Smoked Walnut (52"-54")	●	●	●	●	●	●	●	●	●	●	●	●	●	●
99008	 Matte Snow White / Cottage White (58"-60")	●	●	●			●	●	●	●	●	●			
99009	 Burnt Walnut / Walnut Veneer (58"-60")	●	●	●	●	●	●	●	●	●	●	●			
99010	 Walnut Carved Wood (52"-54")	●	●	●	●	●	●	●	●	●	●	●			
99011	 Blackened Pecan Carved Wood (52"-54")	●	●	●	●	●	●	●	●	●	●	●	●	●	●
99012	 Matte Snow White (52"-54")	*	*	*			*		*		*	*			
99013	 Black Mahogany (52"-54")	*	*	*	*	*	*	*	*	*	*	*			
99014	 Cottage White Beadboard (52"-54")							*		*			*	*	*





## 54084

Brushed Nickel motor shown with 99007 Smoked Walnut / Espresso veneer blades (sold separately)

The smart-looking Academy® teaches an important lesson in design flexibility. With its transitional styling and a wide selection of finish options, the Academy is a scholarly choice for living rooms, great rooms, bedrooms, or any other room in the house.

### FEATURES

- Direct Drive™ motor / lifetime motor warranty
- 54"-60" blade span
- Multiple blade finish choices available (blades sold separately)
- 172 x 20 motor
- Light kits sold separately

ACADEMY®



### MOTOR FINISHES



A



B

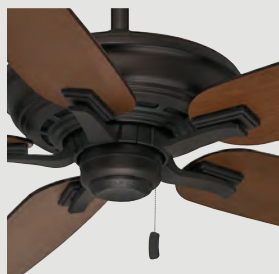

C

#### A: 54083

Snow White motor shown with 99005 Matte Snow White / Cottage White blades

#### B: 54084

Brushed Nickel motor shown with 99007 Smoked Walnut / Espresso veneer blades

#### C: 54085

Maiden Bronze motor shown with 99006 Walnut / Burnt Walnut veneer blades

### BLADES

Customize your fan with blades that reflect your style. Choose from a variety of finishes and shapes. See foldout on page 15.



### LIGHTING

Our design team's recommended lighting option.



#### 99103

Four-Light Fitter in Brushed Nickel

#### 99041

2 1/4" Side Glass with Slanted Shape in Cased White

For all other compatible light fixtures, see pages 127-130.

### CONTROLS



#### Included

4-Speed Pullchain



#### 99019 (optional)

Universal Control System  
Four-speed remote control and receiver with full-range light dimming and CFL mode.

### DIMENSIONS AND ENERGY INFORMATION (AT HIGH SPEED)\*

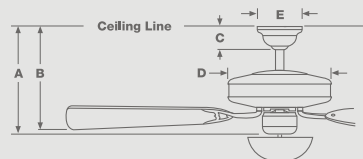

Dimensions	Airflow
A: 13.11"	7,156 cfm
B: 10.95"	Electricity Use
C: 2.75"	80-watt
D: 13.72"	Airflow Efficiency
E: 6.49"	89 cfm/watt
F: -	

\*Energy information based on 99004 blade set.

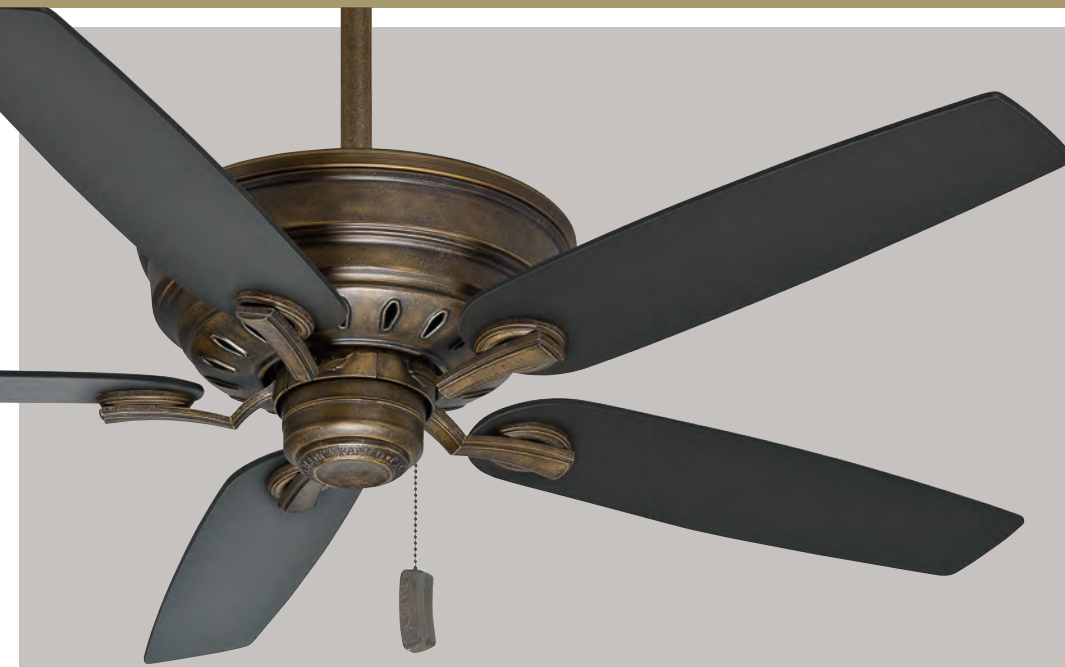

## 54117

Aged Bronze motor shown with 99007 Espresso/Smoked Walnut blades (sold separately)

When a room beckons for something simple or minimal, the customizable Adelaide answers the call.

### FEATURES

- Direct Drive™ motor / lifetime motor warranty
- 54"-60" blade span
- Multiple blade finish choices available (blades sold separately)
- 172 x 20 motor
- Light kits sold separately

# ADELAIDE



### MOTOR FINISHES



A

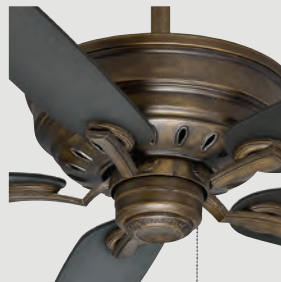

B



C

#### A: 54116

Antique Brass motor shown with 99002 Burnt Walnut / Walnut veneer blades

#### B: 54117

Aged Bronze motor shown with 99007 Espresso/Smoked Walnut blades

#### C: 54118

Snow White motor shown with 99174 High-Gloss Snow White blades

### BLADES

Customize your fan with blades that reflect your style. Choose from a variety of finishes and shapes. See foldout on page 15.



### LIGHTING

Our design team's recommended lighting option.



#### 99087

Outdoor Four-Light Fixture in Aged Bronze

For all other compatible light fixtures, see pages 127-130.

### CONTROLS



**Included**  
4-Speed Pullchain



**99019 (optional)**  
Universal Control System  
Four-speed remote control and receiver with full-range light dimming and CFL mode.

### DIMENSIONS AND ENERGY INFORMATION (AT HIGH SPEED)

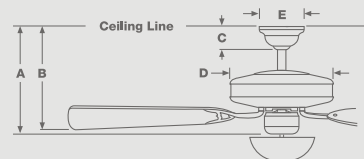

Dimensions		Airflow
A:	13.11"	6,289 cfm
B:	11.70"	Electricity Use
C:	2.75"	80-watt
D:	13.99"	Airflow Efficiency
E:	6.49"	78 cfm/watt
F:	-	

\*Energy information based on 99004 blade set.



## 54121

Industrial Rust motor shown with 99175 Light Walnut Veneer blades (sold separately)

With a more modern look, the Areto cannot be beat when it comes to making it your own. The Areto is Custom Casablanca's most contemporary fan to date.

### FEATURES

- Direct Drive™ motor / lifetime motor warranty
- 54"-60" blade span
- Multiple blade finish choices available (blades sold separately)
- 172 x 20 motor
- Light kits sold separately

## ARETO



### MOTOR FINISHES



A



B



C

#### A: 54120

Brushed Nickel motor shown with 99007 Espresso / Smoked Walnut veneer blades

#### B: 54121

Industrial Rust motor shown with 99175 Light Walnut Veneer blades

#### C: 54122

Snow White motor shown with 99005 Matte Snow White / Cottage White blades

### BLADES

Customize your fan with blades that reflect your style. Choose from a variety of finishes and shapes. See foldout on page 15.



### LIGHTING

Our design team's recommended lighting option.

**99023**  
Glass Bowl Fitter

**99059**  
Cased White Glass Bowl



For all other compatible light fixtures, see pages 127-130.

### CONTROLS



**Included**  
4-Speed Pullchain



**99019 (optional)**  
Universal Control System  
Four-speed remote control and receiver with full-range light dimming and CFL mode.

### DIMENSIONS AND ENERGY INFORMATION (AT HIGH SPEED)

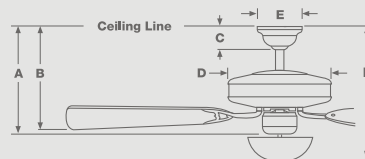

Dimensions	Airflow
A: 13.11"	6,200 cfm
B: 11.74"	Electricity Use
C: 2.75"	82-watt
D: 10.50"	Airflow Efficiency
E: 6.49"	75 cfm/watt
F: -	

\*Energy information based on 99004 blade set.



## 55019

Brushed Nickel motor shown with 99007 Smoked Walnut / Espresso veneer blades (sold separately)

Traditional style meets modern functionality. The same artisan-inspired feel of the classic Brescia® with our innovative four-speed wall control.

### FEATURES

- Direct Drive™ motor / lifetime motor warranty
- 54"-60" blade span
- Multiple blade finish choices available (blades sold separately)
- 188 x 20 motor
- Light kits sold separately

## BRESCIA® CONTROL



### MOTOR FINISHES



A

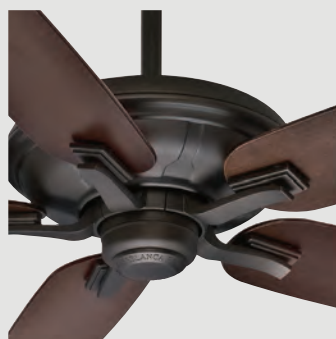

B

#### A: 55019

Brushed Nickel motor shown with 99007 Smoked Walnut / Espresso veneer blades

#### B: 55020

Maiden Bronze motor shown with 99006 Burnt Walnut / Walnut veneer blades

### BLADES

Customize your fan with blades that reflect your style. Choose from a variety of finishes and shapes. See foldout on page 15.



### LIGHTING

Our design team's recommended lighting option.

#### 99103

Four-Light Fitter in Brushed Nickel



#### 99041

2 1/4" Side Glass with Slanted Shape in Cased White

For all other compatible light fixtures, see pages 127-130.

### CONTROLS



#### Included

**Universal Control**  
Four-speed wall control with full-range light dimming, reversing and CFL mode.



#### 99020 (optional)

**Universal Remote**  
Four-speed remote control with full-range light dimming, reversing and CFL mode.

### DIMENSIONS AND ENERGY INFORMATION (AT HIGH SPEED)

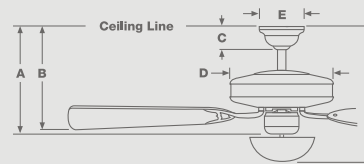

Dimensions	Airflow
A: 12.12"	7,282 cfm
B: 10.54"	Electricity Use
C: 2.75"	88-watt
D: 14.04"	Airflow Efficiency
E: 6.49"	83 cfm/watt
F: -	

\*Energy information based on 99004 blade set.



## 55015

Brushed Cocoa motor shown with 99009 Walnut / Burnt Walnut veneer blades (sold separately)

The Brescia® fan brings warmth and beauty to any room setting. For an arts and crafts inspired look, select richly toned wood blades.

### FEATURES

- Direct Drive™ motor / lifetime motor warranty
- 54"-60" blade span
- Multiple blade finish choices available (blades sold separately)
- 188 x 20 motor
- Light kits sold separately

## BRESCIA® PULLCHAIN



### MOTOR FINISHES

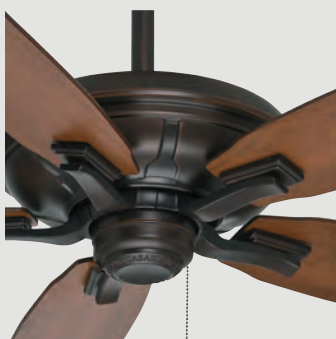

A



B

#### A: 55015

Brushed Cocoa motor shown with 99009 Walnut / Burnt Walnut veneer blades

#### B: 55016

Brushed Nickel motor shown with 99007 Smoked Walnut / Espresso veneer blades

### BLADES

Customize your fan with blades that reflect your style. Choose from a variety of finishes and shapes. See foldout on page 15.



### LIGHTING

Our design team's recommended lighting option.



#### 99090

Outdoor Four-Light Fixture in Brushed Cocoa

For all other compatible light fixtures, see pages 127-130.

### CONTROLS



**Included**  
4-Speed Pullchain



**99019 (optional)**  
Universal Control System  
Four-speed remote control and receiver with full-range light dimming and CFL mode.

### DIMENSIONS AND ENERGY INFORMATION (AT HIGH SPEED)

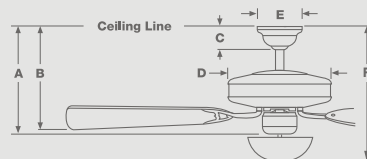

Dimensions	Airflow
A: 12.12"	7,533 cfm
B: 10.54"	Electricity Use
C: 2.75"	86-watt
D: 14.04"	Airflow Efficiency
E: 6.49"	88 cfm/watt
F: -	

\*Energy information based on 99004 blade set.





## 54029

Brushed Nickel motor shown with 99007 Smoked Walnut / Espresso Veneer blades. (sold separately)

Subtle sophistication is a dominant theme in today's décor. With a soft, sculpted look and the nautical suggestion of seashells, no other fan compliments this attitude like the damp-rated Capistrano®.

### FEATURES

- Direct Drive™ motor / lifetime motor warranty
- 54"-60" blade span
- Multiple blade finish choices available (blades sold separately)
- Select models ETL rated for damp or humid locations
- 172 x 20 motor
- Light kits sold separately

CAPISTRANO®



### MOTOR FINISHES



A



B

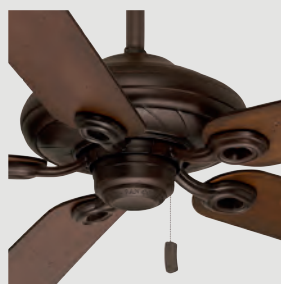

C

#### A: 54028

Snow White motor shown with 99001 Matte Snow White / Cottage White blades

#### B: 54029

Brushed Nickel motor shown with 99007 Smoked Walnut / Espresso Veneer blades  
*This finish is not damp rated.*

#### C: 54030

Brushed Cocoa motor shown with 99003 Wine Country /Vintage Rosewood Distressed Veneer blades

### BLADES

Customize your fan with blades that reflect your style. Choose from a variety of finishes and shapes. See foldout on page 15.



### LIGHTING

Our design team's recommended lighting option.



#### 99023

Glass Bowl Fitter

#### 99061

Cased White Glass Bowl

For all other compatible light fixtures, see pages 127-130.

### CONTROLS



**Included**  
4-Speed Pullchain



**99019 (optional)**  
Universal Control System  
Four-speed remote control and receiver with full-range light dimming and CFL mode.

### DIMENSIONS AND ENERGY INFORMATION (AT HIGH SPEED)

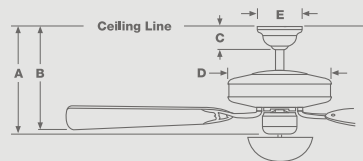

Dimensions	Airflow
A: 13.12"	6,863 cfm
B: 11.67"	Electricity Use
C: 2.75"	81-watt
D: 12.50"	Airflow Efficiency
E: 6.50"	85 cfm/watt
F: -	

\*Energy information based on 99004 blade set.



## 55012

Cottage White motor shown with 99014 Cottage White Beadboard All-Weather blades (sold separately)

Transport yourself to a secluded beach house from any room in your home. With its delightfully simple styling, the Charthouse® creates a relaxed, airy feel that will truly take you away. Choose the perfect blade and finish combination to match your style.

### FEATURES

- Direct Drive™ motor / lifetime motor warranty
- 54"-60" blade span
- Multiple blade finish choices available (blades sold separately)
- ETL rated for wet locations
- 188 x 20 motor
- Light kits sold separately

# CHARTHOUSE®



### MOTOR FINISHES

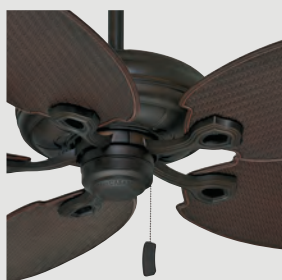

A

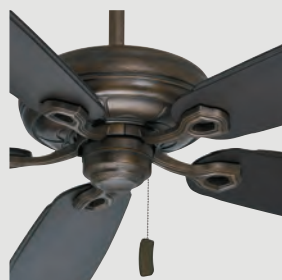

B

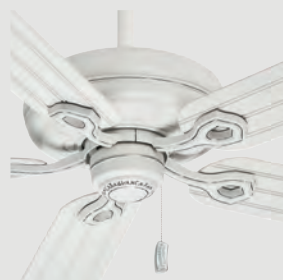

C

#### A: 55010

Maiden Bronze motor shown with 99016 Plantation Wicker All-Weather blades

#### B: 55011

Aged Bronze motor shown with 99018 Espresso All-Weather blades

#### C: 55012

Cottage White motor shown with 99014 Cottage White Beadboard All-Weather blades

### BLADES

Customize your fan with blades that reflect your style. Choose from a variety of finishes and shapes. See foldout on page 15.



### LIGHTING

Our design team's recommended lighting option.



#### 99075

Low Profile Fitter in Cottage White

#### 99072

Low Profile Glass in Cased White

For all other compatible light fixtures, see pages 127-130.

### CONTROLS



#### Included

4-Speed Pullchain



#### 99019 (optional)

Universal Control System  
Four-speed remote control and receiver with full-range light dimming and CFL mode.

### DIMENSIONS AND ENERGY INFORMATION (AT HIGH SPEED)

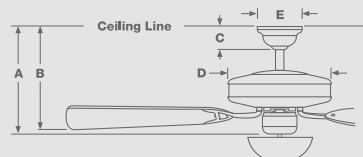

Dimensions	Airflow
A: 13.13"	7,206 cfm
B: 11.92"	Electricity Use
C: 2.75"	86-watt
D: 12.50"	Airflow Efficiency
E: 6.49"	83 cfm/watt
F: -	

\*Energy information based on 99004 blade set.



## 55056

Cottage White motor shown with 99001 Matte Snow White / Cottage White blades (sold separately)

Old World collides with New World in this simple yet elegant design. Add class and style to both traditional and modern interiors.

### FEATURES

- Direct Drive™ motor / lifetime motor warranty
- 54"-60" blade span
- Multiple blade finish choices available (blades sold separately)
- 188 x 20 motor
- Light kits sold separately

COLETTI



### MOTOR FINISHES



A



B

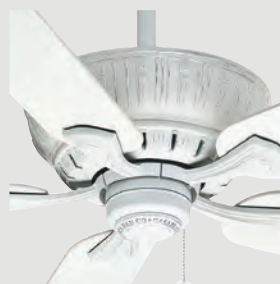

C

#### A: 55054

Aged Bronze motor shown with 99011 Blackened Pecan carved wood blades

#### B: 55055

Brushed Cocoa motor shown with 99003 Vintage Rosewood Distressed / Wine Country Distressed Veneer blades

#### C: 55056

Cottage White motor shown with 99001 Matte Snow White / Cottage White blades

### BLADES

Customize your fan with blades that reflect your style. Choose from a variety of finishes and shapes. See foldout on page 15.



### LIGHTING

Our design team's recommended lighting option.



#### 99023

Glass Bowl Fitter

#### 99061

Cased White Glass Bowl

For all other compatible light fixtures, see pages 127-130.

### CONTROLS



**Included**  
4-Speed Pullchain



**99019 (optional)**  
Universal Control System  
Four-speed remote control and receiver with full-range light dimming and CFL mode.

### DIMENSIONS AND ENERGY INFORMATION (AT HIGH SPEED)

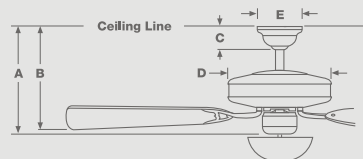

Dimensions	Airflow
A: 13.11"	6,626 cfm
B: 11.69"	Electricity Use
C: 2.75"	86-watt
D: 13.27"	Airflow Efficiency
E: 6.49"	77 cfm/watt
F: -	

\*Energy information based on 99004 blade set.



## 54011

Maiden Bronze motor shown with 99015 Distressed Antique Halifax All-Weather blades (sold separately)

Being one of our most distinctive designs, the Compass Point® shows how something so simple can add so much to a room. It is built to last outside which makes it a fine choice for covered porches and sun rooms. The fan is available in two finishes with a wide range of accessory blade options.

### FEATURES

- Direct Drive™ motor / lifetime motor warranty
- 54"-60" blade span
- Multiple blade finish choices available (blades sold separately)
- ETL rated for damp or humid locations
- 172 x 20 motor
- Light kits sold separately

## COMPASS POINT®



### MOTOR FINISHES



A



B

#### A: 54010

Cottage White motor shown with 99017 Cottage White All-Weather blades

#### B: 54011

Maiden Bronze motor shown with 99015 Distressed Antique Halifax All-Weather blades

### BLADES

Customize your fan with blades that reflect your style. Choose from a variety of finishes and shapes. See foldout on page 15.



### LIGHTING

Our design team's recommended lighting option.



#### 99091

Outdoor Four-Light Fixture in Maiden Bronze

For all other compatible light fixtures, see pages 127-130.

### CONTROLS



**Included**  
4-Speed Pullchain



**99019 (optional)**  
Universal Control System  
Four-speed remote control and receiver with full-range light dimming and CFL mode.

### DIMENSIONS AND ENERGY INFORMATION (AT HIGH SPEED)

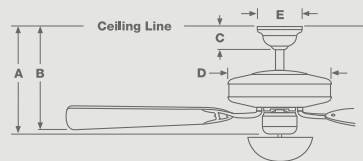

Dimensions	Airflow
A: 13.11"	6,590 cfm
B: 11.58"	Electricity Use
C: 2.75"	83-watt
D: 9.17"	Airflow Efficiency
E: 6.49"	80 cfm/watt
F: -	

\*Energy information based on 99004 blade set.



## 55063

Brushed Nickel motor shown with 99009  
Burnt Walnut / Walnut veneer blades  
(sold separately)

The Crestmont has a strong presence that fits with a variety of styles. Featuring our new wide switch housing for a more modern look, this fan offers traditional composition with a contemporary twist. The design is influenced by Naval architecture, particularly the multi-dimensional appearance of transverse frames found in boat hulls. The interplay between flowing curves and rigid lines throughout the fan body uses these same ideas to create a unique, classic feel.

### FEATURES

- Direct Drive™ motor / lifetime motor warranty
- 54"-60" blade span
- Multiple blade finish choices available (blades sold separately)
- Light kits sold separately
- ETL rated for damp or humid locations
- 188 x 20 motor

# CRESTMONT



### MOTOR FINISHES



A



B



C

#### A: 55063

Brushed Nickel motor shown with 99009  
Burnt Walnut / Walnut veneer blades

#### B: 55064

Brushed Cocoa motor shown with 99009  
Walnut / Burnt Walnut veneer blades

#### C: 55065

Snow White motor shown with 99005  
Matte Snow White / Cottage White blades

### BLADES

Customize your fan with blades that reflect your style. Choose from a variety of finishes and shapes. See foldout on page 15.



### LIGHTING

Our design team's recommended lighting option.



#### 99259

Low Profile Bowl Light  
Fixture with Cased  
White Glass

For all other compatible light  
fixtures, see pages 127-130.

### CONTROLS



#### Included

Universal Control  
Four-speed wall control with  
full-range light dimming,  
reversing and CFL mode.



#### 99020 (optional)

Universal Remote  
Four-speed remote control with  
full-range light dimming,  
reversing and CFL mode.

### DIMENSIONS AND ENERGY INFORMATION (AT HIGH SPEED)

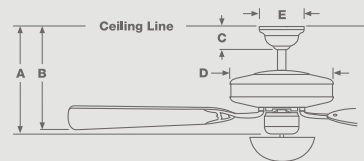

Dimensions	Airflow
A: 12.50"	6,519 cfm
B: 11.77"	Electricity Use
C: 2.75"	86-watt
D: 13.08"	Airflow Efficiency
E: 6.49"	76 cfm/watt
F: -	

\*Energy information based on 99004 blade set.



## 59534

Brushed Nickel motor shown with 99004  
Burnt Walnut / Walnut veneer blades  
(sold separately)

The Holliston is the one of the first fans to showcase our new wide switch housing. With its interplay between aerodynamic curves and long straight lines, the design is a nod to Streamline Moderne architecture and furniture. The broad curvature throughout the design emits a fresh and approachable vibe that will compliment your own personal style.

### FEATURES

- Direct Drive™ motor / lifetime motor warranty
- 54"-60" blade span
- Multiple blade finish choices available (blades sold separately)
- 188 x 20 motor
- Light kits sold separately

## HOLLISTON



### MOTOR FINISHES



A



B



C

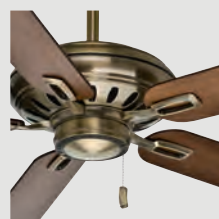

D

#### A: 59532

Brushed Cocoa motor shown with 99004  
Burnt Walnut / Walnut veneer blades

#### B: 59533

Snow White motor shown with 99008  
Matte Snow White / Cottage White blades

#### C: 59534

Brushed Nickel motor shown with 99004  
Burnt Walnut / Walnut veneer blades

#### D: 59535

Antique Brass motor shown with 99004  
Burnt Walnut / Walnut veneer blades

### BLADES

Customize your fan with blades that reflect your style. Choose from a variety of finishes and shapes. See foldout on page 15.



### LIGHTING

Our design team's recommended lighting option.

#### 99183

LED Bowl Fitter



#### 99059

Cased White Glass Bowl

For all other compatible light fixtures, see pages 127-130.

### CONTROLS



#### Included

4-Speed Pullchain



#### 99019 (optional)

Universal Control System

Four-speed remote control and receiver with full-range light dimming and CFL mode.

### DIMENSIONS AND ENERGY INFORMATION (AT HIGH SPEED)

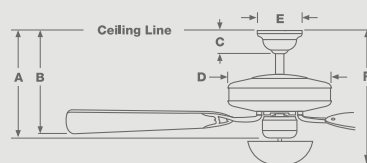

#### Dimensions

- A: 12.47"
- B: 10.50"
- C: 2.75"
- D: 13.94"
- E: 6.49"
- F: -

#### Airflow

7,001 cfm

#### Electricity Use

85-watt

#### Airflow Efficiency

82 cfm/watt

\*Energy information based on 99004 blade set.



## 55032

Antique Brass motor shown with 99003 Vintage Rosewood / Wine Country Distressed Veneer blades (sold separately)

With a timeless classic design, superb air movement, energy efficiency, and a variety of motor finishes, the Panama® Control has everything you could possibly want in a fan. It could be the only fan you would ever need.

### FEATURES

- Direct Drive™ motor / lifetime motor warranty
- 52"-58" blade span
- Multiple blade finish choices available (blades sold separately)
- Select models ETL rated for damp or humid locations
- 188 x 20 motor
- Light kits sold separately

## PANAMA® CONTROL



### MOTOR FINISHES



A



B



C



D



E

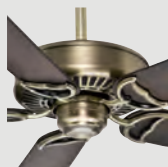

F

#### A: 55027

Snow White motor shown with 99001 Matte Snow White / Cottage White blades

#### B: 55028

Brushed Nickel motor shown with 99007 Espresso/Smoked Walnut veneer blades.

*This finish is not damp rated.*

#### C: 55029

Aged Bronze motor shown with 99002 Burnt Walnut / Walnut veneer blades

#### D: 55030

Brushed Cocoa motor shown with 99002 Walnut / Burnt Walnut veneer blades

#### E: 55031

Cottage White motor shown with 99014 Cottage White Beadboard All-Weather blades

#### F: 55032

Antique Brass motor shown with 99003 Vintage Rosewood / Wine Country Distressed veneer blades

*This finish is not damp rated.*

### BLADES

Customize your fan with blades that reflect your style. Choose from a variety of finishes and shapes. See foldout on page 15.



### LIGHTING

Our design team's recommended lighting option.

#### 99055

Globe Fixture in Antique Brass



For all other compatible light fixtures, see pages 127-130.

### CONTROLS



#### Included

Universal Control  
Four-speed wall control with full-range light dimming, reversing and CFL mode.



#### 99020 (optional)

Universal Remote  
Four-speed remote control with full-range light dimming, reversing and CFL mode.

### DIMENSIONS AND ENERGY INFORMATION (AT HIGH SPEED)

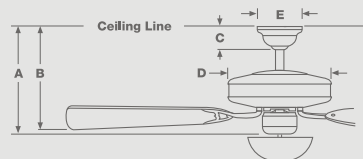

Dimensions	Airflow
A: 12.36"	7,375 cfm
B: 11.19"	Electricity Use
C: 2.75"	84-watt
D: 12.00"	Airflow Efficiency
E: 6.50"	88 cfm/watt
F: -	

\*Energy information based on 99004 blade set.



## 55023

Aged Bronze motor shown with 99002  
Burnt Walnut / Walnut Veneer blades  
(sold separately)

All of the great features of the Panama® with an added pullchain. With a classic design, excellent air movement, energy efficiency, and a wide variety of motor and blade finishes, there is no need to look any further.

### FEATURES

- Direct Drive™ motor / lifetime motor warranty
- 52"-58" blade span
- Multiple blade finish choices available (blades sold separately)
- Select models ETL rated for damp or humid locations
- 188 x 20 motor
- Light kits sold separately

## PANAMA® PULLCHAIN



### MOTOR FINISHES



A



B



C



D

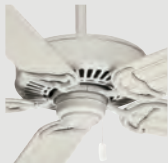

E

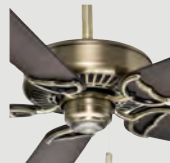

F

#### A: 55021

Snow White motor shown with 99001  
Matte Snow White / Cottage White blades

#### B: 55022

Brushed Nickel motor shown with 99007  
Espresso / Smoked Walnut Veneer blades  
*This finish is not damp rated.*

#### C: 55023

Aged Bronze motor shown with 99002  
Burnt Walnut / Walnut Veneer blades

#### D: 55024

Brushed Cocoa motor shown with 99002  
Walnut / Burnt Walnut Veneer blades

#### E: 55025

Cottage White motor shown with 99014  
Cottage White Beadboard All-Weather blades

#### F: 55026

Antique Brass motor shown with 99003  
Vintage Rosewood / Wine Country Distressed Veneer blades  
*This finish is not damp rated.*

### BLADES

Customize your fan with blades that reflect your style. Choose from a variety of finishes and shapes. See foldout on page 15.



### LIGHTING

Our design team's recommended lighting option.



#### 99087

Outdoor Four-Light Fixture in Aged Bronze

For all other compatible light fixtures, see pages 127-130.

### CONTROLS



**Included**  
4-Speed Pullchain



**99019 (optional)**  
Universal Control System  
Four-speed remote control and receiver with full-range light dimming and CFL mode.

### DIMENSIONS AND ENERGY INFORMATION (AT HIGH SPEED)

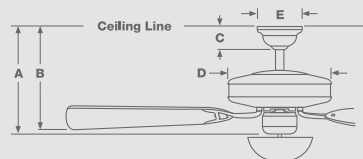

Dimensions	Airflow
A: 12.36"	7,264 cfm
B: 11.18"	Electricity Use
C: 2.75"	91-watt
D: 12.00"	Airflow Efficiency
E: 6.50"	80 cfm/watt
F: -	

\*Energy information based on 99004 blade set.





## 59095

Cottage White motor shown with 99001 Cottage White / Matte Snow White blades (sold separately)

With a timeless classic design, superb air movement, energy efficiency, and a variety of motor finishes, the Panama® XLP Control has everything you could possibly want in a fan. It could be the only fan you would ever need.

### FEATURES

- XLP 2000 Motor / lifetime motor warranty
- 52"-58" blade span
- Multiple blade finish choices available (blades sold separately)
- Light kits sold separately

# PANAMA® XLP CONTROL



### MOTOR FINISHES



A

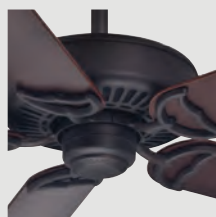

B



C



D

#### A: 59095

Cottage White motor shown with 99001 Cottage White /Matte Snow White blades

#### B: 59096

Maiden Bronze motor shown with 99002 Burnt Walnut / Walnut veneer blades

#### C: 59097

Snow White motor shown with 99001 Cottage White /Matte Snow White blades

#### D: 59098

Brushed Nickel motor shown with 99002 Burnt Walnut / Walnut veneer blades

### BLADES

Customize your fan with blades that reflect your style. Choose from a variety of finishes and shapes. See foldout on page 15.



### LIGHTING

Our design team's recommended lighting option.



#### 99075

Low Profile Fitter in Cottage White

#### 99072

Low Profile Glass in Cased White

For all other compatible light fixtures, see pages 127-130.

### CONTROLS



#### Included

Universal Control  
Four-speed wall control with full-range light dimming, reversing and CFL mode.



#### 99020 (optional)

Universal Remote  
Four-speed remote control with full-range light dimming, reversing and CFL mode.

### DIMENSIONS AND ENERGY INFORMATION (AT HIGH SPEED)

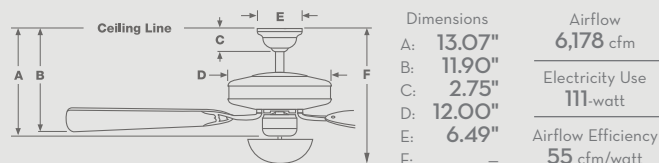

\*Energy information based on 99004 blade set.



AINSWORTH GALLERY CEILING FAN

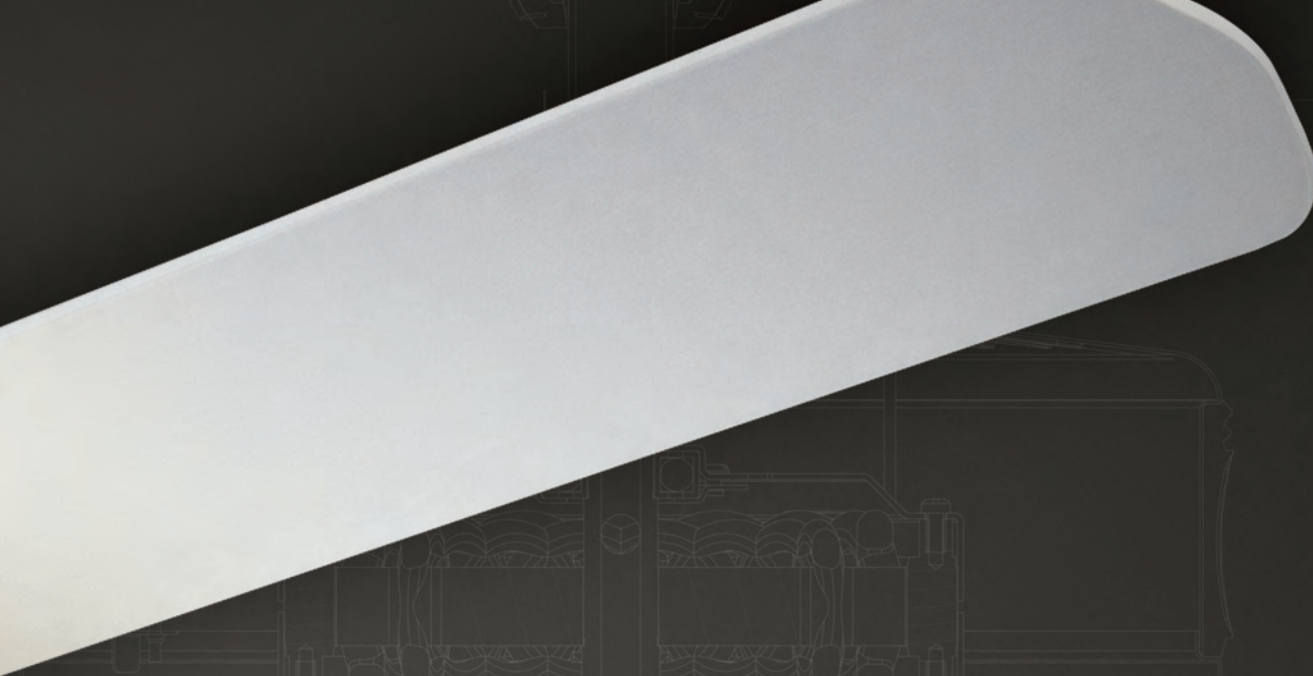

4

FINISH CODE: FF



FINISH CODE



# TRADITIONAL

3

FINISH CODE: GL

14

FINISH CODE: R

1173  
1297/9

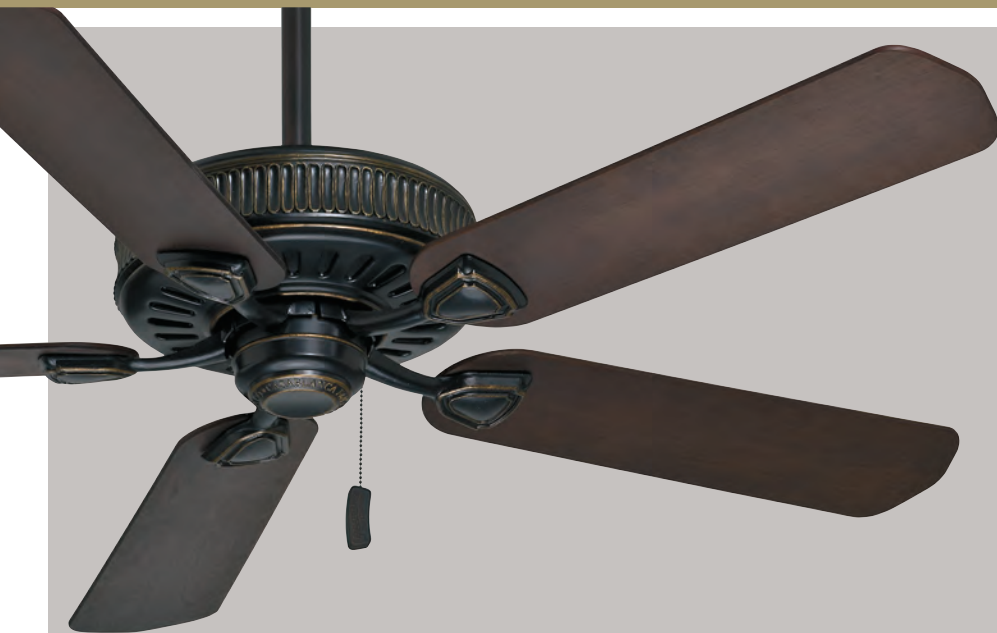

## 54002

Basque Black motor with reversible Espresso / Smoked Walnut blades

The timeless beauty of the Ainsworth in just the size you're looking for.

### FEATURES

- Direct Drive™ motor / lifetime motor warranty
- 54" blade span
- Set of 5 blades included
- Includes low-ceiling hanging option
- 172 x 20 motor
- Light kits sold separately

## AINS WORTH 54"



### MOTOR & BLADE FINISHES



A

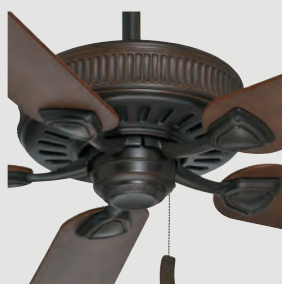

B

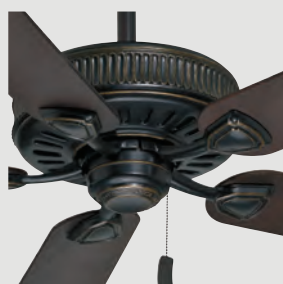

C

#### A: 54000

Cottage White motor with Cottage White blades

#### B: 54001

Brushed Cocoa motor with reversible Distressed Walnut / Dark Walnut blades

#### C: 54002

Basque Black motor with reversible Espresso / Smoked Walnut blades

### CONTROLS



**Included**  
4-Speed Pullchain



**99019 (optional)**  
Universal Control System  
Four-speed remote control and receiver with full-range light dimming and CFL mode.

### LIGHTING

Our design team's recommended lighting option.



#### 99023

Glass Bowl Fitter in Brushed Cocoa

#### 99058

Glass Bowl in Tea Stain

For all other compatible light fixtures, see pages 127-130.

### DIMENSIONS AND ENERGY INFORMATION (AT HIGH SPEED)

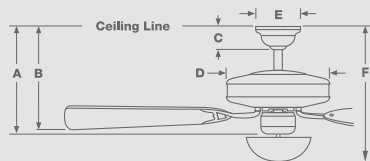

Dimensions	Airflow
A: 13.11"	6,125 cfm
B: 11.73"	Electricity Use
C: 2.75"	78-watt
D: 12.41"	Airflow Efficiency
E: 6.49"	79 cfm/watt
F: -	



## 55002

Provence Crackle motor with reversible Espresso / Smoked Walnut blades

Details are everything. With meticulously carved exquisite columns in the motor housing, the Ainsworth 60" has a sophisticated, timeless look. It is a quality great room fan at an excellent value.

### FEATURES

- Direct Drive™ motor / lifetime motor warranty
- 60" blade span
- Set of 5 blades included
- Includes low-ceiling hanging option
- 188 x 20 motor
- Light kits sold separately

# AINSWORTH 60"



### MOTOR & BLADE FINISHES



A



B



C

#### A: 55000

Cottage White motor with Cottage White blades

#### B: 55001

Brushed Cocoa motor with reversible Distressed Walnut / Dark Walnut blades

#### C: 55002

Provence Crackle motor with reversible Espresso / Smoked Walnut blades

### CONTROLS



**Included**  
4-Speed Pullchain



**99019 (optional)**  
Universal Control System  
Four-speed remote control and receiver with full-range light dimming and CFL mode.

### LIGHTING

Our design team's recommended lighting option.



#### 99104

Four-light Fitter in Provence Crackle

#### 99044

2 1/4" Side Glass with Ribbed Deco Shape in Cased White

For all other compatible light fixtures, see pages 127-130.

### DIMENSIONS AND ENERGY INFORMATION (AT HIGH SPEED)

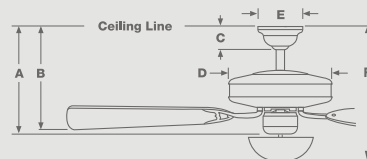

Dimensions	
A:	13.11"
B:	11.73"
C:	2.75"
D:	12.41"
E:	6.49"
F:	-

Airflow	
	7,093 cfm
Electricity Use	
	83-watt
Airflow Efficiency	
	85 cfm/watt



## 54006

Onyx Bengal motor with reversible Distressed Walnut / Dark Walnut blades and Toffee glass

With a truly distinguished look at just the right size, the Ainsworth Gallery 54" has one of Casablanca's finest ornate three-light fixtures.

### FEATURES

- Direct Drive™ motor / lifetime motor warranty
- 54" blade span
- Set of 5 blades included
- Includes three-light fitter with three 14-watt medium-based CFL bulbs
- Includes low-ceiling hanging option
- 172 x 20 motor

# AINSWORTH GALLERY 54"



BLADES included

### MOTOR & BLADE FINISHES



A



B



C

#### A: 54005

Cottage White motor with Cottage White blades and Snowflake Linen glass

#### B: 54006

Onyx Bengal motor with reversible Distressed Walnut / Dark Walnut blades and Toffee glass

#### C: 54007

Basque Black motor with reversible Smoked Walnut / Espresso blades and Champagne Scavo glass

### CONTROLS



**Included**  
4-Speed Pullchain



**99019 (optional)**  
Universal Control System  
Four-speed remote control and receiver with full-range light dimming and CFL mode.

### DIMENSIONS AND ENERGY INFORMATION (AT HIGH SPEED)

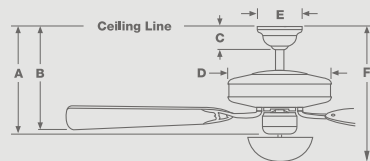

Dimensions	Airflow
A: 13.11"	6,095 cfm
B: 11.73"	Electricity Use
C: 2.75"	80-watt
D: 12.41"	Airflow Efficiency
E: 6.49"	76 cfm/watt
F: 19.56"	



## 55006

Onyx Bengal motor with reversible Dark Walnut / Distressed Walnut blades and Toffee glass

The classic, architectural style of the Ainsworth with a simple yet tasteful bowl light fixture. The Ainsworth Gallery 60" is the perfect complement to any room. It also comes with a wall-mounted control.

### FEATURES

- Direct Drive™ motor / lifetime motor warranty
- 60" blade span
- Set of 5 blades included
- Includes bowl light fixture with three 60-watt candelabra incandescent bulbs
- Includes low-ceiling hanging option
- 188 x 20 motor

# AINSWORTH GALLERY 60"



### MOTOR & BLADE FINISHES



A



B



C

#### A: 55005

Cottage White motor with Cottage White blades and Snowflake Linen glass

#### B: 55006

Onyx Bengal motor with reversible Dark Walnut / Distressed Walnut blades and Toffee glass

#### C: 55007

Basque Black motor with reversible Espresso / Smoked Walnut blades and Champagne Scavo glass

### CONTROLS



**Included**  
Universal Control  
Four-speed wall control with full-range light dimming, reversing and CFL mode.



**99020 (optional)**  
Universal Remote  
Four-speed remote control with full-range light dimming, reversing and CFL mode.

### DIMENSIONS AND ENERGY INFORMATION (AT HIGH SPEED)

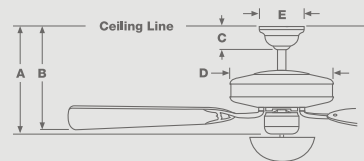

Dimensions	Airflow
A: 13.11"	7,204 cfm
B: 11.73"	Electricity Use
C: 2.75"	86-watt
D: 12.41"	Airflow Efficiency
E: 6.49"	83 cfm/watt
F: 18.88"	



## 54032

Antique Pewter motor with reversible Smoked Walnut / Medium Chestnut blades and Cased White glass

A classic, long-standing design in an updated, modern model with five blades. Loaded with stylish, practical features, the Capistrano® Gallery fan includes a four-light fixture and is an excellent value.

### FEATURES

- Direct Drive™ motor / lifetime motor warranty
- 52" blade span
- Set of 5 blades included
- Includes four-light fitter with four 40-watt candelabra incandescent bulbs
- 172 x 20 motor

*Tip*  
Create a one-of-a-kind Capistrano with Custom Casablanca (page 22)

## CAPISTRANO® GALLERY



### MOTOR & BLADE FINISHES



A



B



C

#### A: 54031

Acadia motor with reversible Dark Walnut / Smoked Walnut blades and Toffee glass

#### B: 54032

Antique Pewter motor with reversible Smoked Walnut / Medium Chestnut blades and Cased White glass

#### C: 54033

Snow White motor with Snow White blades and Cased White glass

### CONTROLS



#### Included

Universal Control  
Four-speed wall control with full-range light dimming, reversing and CFL mode.



#### 99020 (optional)

Universal Remote  
Four-speed remote control with full-range light dimming, reversing and CFL mode.

### DIMENSIONS AND ENERGY INFORMATION (AT HIGH SPEED)

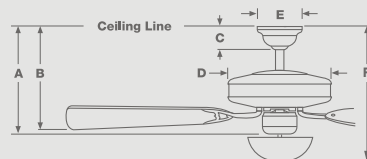

Dimensions	
A:	13.12"
B:	11.67"
C:	2.75"
D:	12.50"
E:	6.50"
E:	19.00"

Airflow	5,965 cfm
Electricity Use	83-watt
Airflow Efficiency	72 cfm/watt





## 54021

Brushed Nickel motor with reversible Walnut / Burnt Walnut blades

With outstanding air movement, ENERGY STAR® rated efficiency, and Casablanca durability, the Concentra® is still at the lowest price of any of our collections.

### FEATURES

- Direct Drive™ motor / lifetime motor warranty
- 54" blade span
- Set of 5 blades included
- 172 x 20 motor
- Light kits sold separately

CONCENTRA®



### MOTOR & BLADE FINISHES



A



B



C

#### A: 54019

Snow White motor with Matte Snow White blades

#### B: 54020

Brushed Cocoa motor with reversible Dark Walnut / Distressed Walnut blades

#### C: 54021

Brushed Nickel motor with reversible Walnut / Burnt Walnut blades

### CONTROLS



**Included**  
4-Speed Pullchain



**99019 (optional)**  
Universal Control System  
Four-speed remote control and receiver with full-range light dimming and CFL mode.

### LIGHTING

Our design team's recommended lighting option.



**99103**  
Four-Light Fitter in Brushed Nickel

**99035**  
2 1/4" Side Glass with Bell Shape in Cased White

For all other compatible light fixtures, see pages 127-130.

### DIMENSIONS AND ENERGY INFORMATION (AT HIGH SPEED)

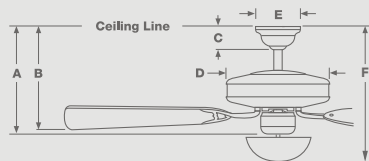

#### Dimensions

- A: 13.12"  
B: 11.39"  
C: 2.75"  
D: 12.50"  
E: 6.49"  
F: -

#### Airflow

6,129 cfm

#### Electricity Use

81-watt

#### Airflow Efficiency

76 cfm/watt



## 54024

Acadia motor with reversible Clove / Smoked Walnut blades and Tea Stain glass

The Concentra® Gallery combines the simple and chic of the traditional meets transitional design of the Concentra® with a complementary bowl light fixture.

### FEATURES

- Direct Drive™ motor / lifetime motor warranty
- 54" blade span
- Set of 5 blades included
- Includes bowl light fixture with two 13-watt medium-based CFL bulbs
- 172 x 20 motor

## CONCENTRA® GALLERY



BLADES  
included

### MOTOR & BLADE FINISHES



A



B



C



D

#### A: 54022

Snow White motor with Matte Snow White blades and Cased White glass

#### B: 54023

Brushed Nickel motor with reversible Walnut / Burnt Walnut blades and Cased White glass

#### C: 54024

Acadia motor with reversible Clove / Smoked Walnut blades and Tea Stain glass

#### D: 54025

Antique Brass motor with reversible Smoked Walnut / Clove blades and Champagne Scavo glass

### CONTROLS



**Included**  
4-Speed Pullchain



**99019 (optional)**  
Universal Control System  
Four-speed remote control and receiver with full-range light dimming and CFL mode.

### DIMENSIONS AND ENERGY INFORMATION (AT HIGH SPEED)

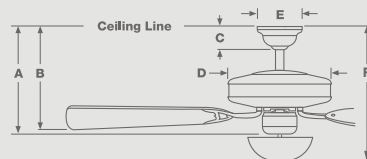

Dimensions	
A:	13.12"
B:	11.39"
C:	2.75"
D:	12.50"
E:	6.49"
F:	18.77"

Airflow	6,129 cfm
Electricity Use	81-watt
Airflow Efficiency	76 cfm/watt



## 53194

Cottage White motor with Cottage White / Cottage White veneer blades

With intricate details on the motor housing, the Fordham adds a touch of class to smaller rooms. Reminiscent of ornate cottage furniture, the scrolls are elegant and complex to create a nice juxtaposition with the minimal features throughout the rest of the fan. This modest design is a perfect fit for traditional or casual styles.

### FEATURES

- Direct Drive™ motor / lifetime motor warranty
- 44" blade span
- Set of 5 blades included
- 172 x 12 motor
- Light kits sold separately

# FORDHAM



### MOTOR & BLADE FINISHES



A



B

#### A: 53194

Cottage White motor shown with Cottage White / Cottage White veneer blades

#### B: 53195

Brushed Cocoa motor shown with Distressed Walnut / Dark Walnut veneer blades

### CONTROLS



**Included**  
4-Speed Pullchain



**99019 (optional)**  
Universal Control System  
Four-speed remote control and receiver with full-range light dimming and CFL mode.

### LIGHTING

Our design team's recommended lighting option.



#### 99031

Four-Light Fitter in Cottage White

#### 99035

2 1/4" Side Glass with Bell Shape in Cased White

For all other compatible light fixtures, see pages 127-130.

### DIMENSIONS AND ENERGY INFORMATION (AT HIGH SPEED)

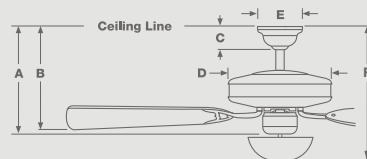

Dimensions	
A:	12.61"
B:	10.88"
C:	2.75"
D:	10.08"
E:	6.49"
F:	4.57"

Airflow	
	4,955 cfm
Electricity Use	
	64-watt
Airflow Efficiency	
	77 cfm/watt



## 59512

Brushed Cocoa motor with reversible Distressed Walnut / Dark Walnut blades

A new spin on the original five-bladed fan, the Panama® DC features a larger, 54-inch span and our extremely powerful DC motor. That means it can accommodate a larger room with higher efficiency—and it's ENERGY STAR® qualified. It is a new, true classic.

### FEATURES

- DC motor / lifetime motor warranty
- 54" blade span
- Set of 5 blades included
- Light kits sold separately

## PANAMA® DC



### MOTOR & BLADE FINISHES



A



B



C

#### A: 59510

Snow White motor with Matte Snow White blades

#### B: 59511

Brushed Nickel motor with reversible Walnut / Burnt Walnut blades

#### C: 59512

Brushed Cocoa motor with reversible Distressed Walnut / Dark Walnut blades

### CONTROLS



#### Included

DC 6-speed  
Six-speed control with full-range light dimming and reversing.

### LIGHTING

Our design team's recommended lighting option.



#### 99255

CFL Low Profile Fitter in Brushed Cocoa

#### 99073

Low Profile Glass in Cased White

For all other compatible light fixtures, see pages 127-130.

### DIMENSIONS AND ENERGY INFORMATION (AT HIGH SPEED)

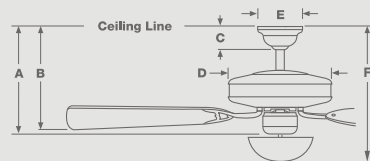

#### Dimensions

- A: 13.29"  
B: 11.69"  
C: 2.75"  
D: 12.00"  
E: 6.49"  
F: -

#### Airflow

6,675 cfm

#### Electricity Use

32-watt

#### Airflow Efficiency

206 cfm/watt



## 55059

Antique Pewter motor with espresso blades and cased white glass

A classic, long-standing design is now an updated, modern model with five blades. Loaded with stylish, practical features, the Panama® Gallery fan includes a four-light fixture perfect for the traditional look you are designing for.

### FEATURES

- Direct Drive™ motor / lifetime motor warranty
- 54" blade span
- Set of 5 blades included
- Includes four-light fitter with four 14-watt medium-based CFL bulbs
- 188 x 20 motor
- Select models ETL rated for damp or humid locations

*Tip*  
Create a one-of-a-kind Panama Control with Custom Casablanca (page 28)

## PANAMA GALLERY



### MOTOR & BLADE FINISHES

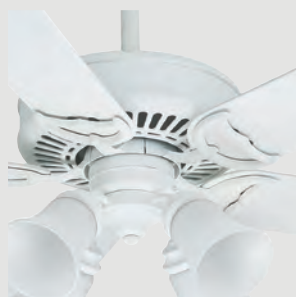

A



B



C



D

#### A: 55058

Architectural White motor with Architectural White blades and Cased White glass

#### B: 55059

Antique Pewter motor with Espresso blades and Cased White glass

*This finish is not damp rated.*

#### C: 55060

Maiden Bronze motor with Reclaimed Antique and Tea Stain glass

#### D: 55061

Bright Brass motor with reversible Burnt Walnut / Walnut blades and Tea Stain glass

*This finish is not damp rated.*

### CONTROLS



**Included**  
Universal Control  
Four-speed wall control with full-range light dimming, reversing and CFL mode.



**99020 (optional)**  
Universal Remote  
Four-speed remote control with full-range light dimming, reversing and CFL mode.

### DIMENSIONS AND ENERGY INFORMATION (AT HIGH SPEED)

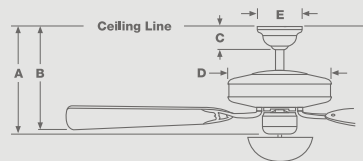

Dimensions	Airflow
A: 12.37"	6,393 cfm
B: 10.96"	Electricity Use
C: 2.75"	89-watt
D: 12.00"	Airflow Efficiency
E: 6.49"	72 cfm/watt
F: 19.17"	

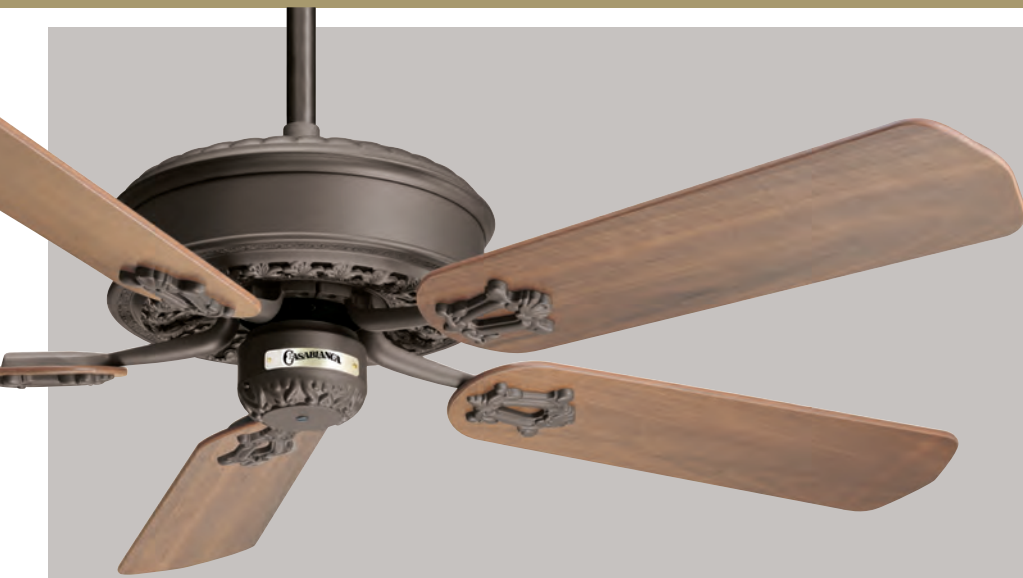

## 60129 (6373Z)

Oil-Rubbed Bronze motor with 62293 Walnut blades (sold separately)

This is where it all began...the original Casablanca fan. The Victorian® series marries classic turn-of-the-century appeal with contemporary innovation and convenience. The richness of the ornate design is enhanced with badge-style blade holders. Optimum performance is achieved with a 15° blade pitch.

### FEATURES

- XLP-2000™ motor / lifetime motor warranty
- 54" blade span
- 4- or 5-blade configuration
- Multiple blade finish choices available (blades sold separately)
- Set of 5 intricately detailed blade medallions included

*Discontinued - while supplies last*

VICTORIAN®



### MOTOR FINISHES



A

### A: 60129 (6373Z)

Oil-Rubbed Bronze motor shown with 62293 Walnut blades

### CONTROLS



#### W-85 (included)

Intelli-Touch3®  
Six-speed wall control with full-range light dimming and reversing.

### BLADES

Customize your fan with blades that reflect your style. Choose from three finishes.



A



B

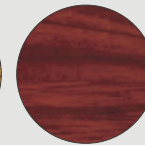

C

### A: 62293 (B103)

Walnut

### B: 61016 (B522)

Antique Oak

### C: 64221 (BB21-WD)

Dark Walnut

*Discontinued-while supplies last*

### DIMENSIONS AND ENERGY INFORMATION (AT HIGH SPEED)

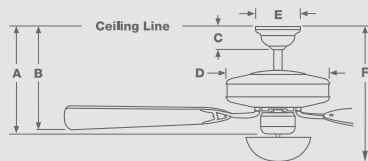

#### Dimensions

A: 13.50"  
B: 11.50"  
C: 3.00"  
D: 13.00"  
E: 5.60"  
F: -

#### Airflow

6,250 cfm  
Electricity Use  
122-watt  
Airflow Efficiency  
51 cfm/watt



**59525**

Brushed Cocoa motor with Dark Walnut All-Weather blades

The ETL damp-rated Wailea® fan, inspired by Casablanca's popular Capistrano® fan, is perfectly suited for small spaces. This 31 inch wide fan is ideal for bathrooms, laundry rooms, walk-in closets, and kitchens where ventilation is needed.

**FEATURES**

- Direct Drive™ motor / lifetime motor warranty
- 31" blade span / 25° blade pitch (optimized for maximum air movement)
- Set of 6 exclusive All-Weather ABS blades included
- Moisture-resistant motor / stainless steel hardware
- Use only damp- or wet-rated light fixtures in damp locations
- 172 x 12 motor
- Light kits sold separately

WAILEA®



**MOTOR & BLADE FINISHES**

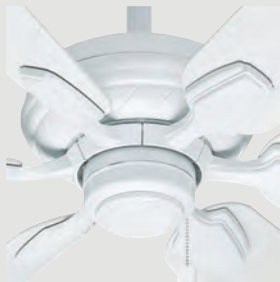

A



B



C

**A: 59523**

Snow White motor with Snow White All-Weather blades

**B: 59524**

Brushed Nickel motor with Dark Walnut All-Weather blades

**C: 59525**

Brushed Cocoa motor with Dark Walnut All-Weather blades

**CONTROLS**



**Included**  
4-Speed Pullchain



**99019 (optional)**  
Universal Control System  
Four-speed remote control and receiver with full-range light dimming and CFL mode.

**LIGHTING**

Our design team's recommended lighting option.



**99078**

Low Profile Fitter in Brushed Cocoa

**99084**

Low Profile Glass in Toffee

For all other compatible light fixtures, see pages 127-130.

**DIMENSIONS AND ENERGY INFORMATION (AT HIGH SPEED)**

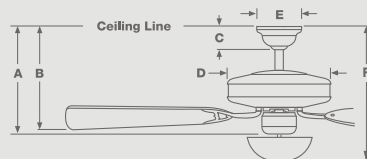

Dimensions		Airflow
A:	12.71"	3,055 cfm
B:	11.26"	Electricity Use 63-watt
C:	3.00"	
D:	8.50"	Airflow Efficiency 48 cfm/watt
E:	5.60"	
F:	-	



ASSY. AIR MO...  
DALLION, BLADE M...  
COVER, ADAPTER  
HOUSING, GROMMET ASSY  
GLASS, GLOBE  
LIGHT KIT, DECORATIVE  
17.2 X 20 SPEC. TOP MOUNT  
BLADE, PLYWOOD

FINISH CODE: F1

19

CASABLANCA FAN CO

FINISH CODE: R



# GLEN ARBOR CEILING FAN

FAN DIA. n 56  
[1422]





10

FINISH CODE:F1

15

FINISH CODE:F1

20

FINISH CODE:BL

C

14

FINISH CODE:FF

16

FINISH CODE:F1

12

FINISH CODE:R

7

FINISH CODE:R

9

FINISH CODE:R

17

FINISH CODE:GL

18

FINISH CODE:R

# TRANSITIONAL



## 54081

Antique Pewter motor with reversible Espresso / Smoked Walnut blades and Cased White glass

Talk about your overachievers. The Academy Gallery takes honors for best all-around with transitional styling, a choice of finish options, and an integrated light bowl fixture.

### FEATURES

- Direct Drive™ motor / lifetime motor warranty
- 54" blade span
- Set of 5 reversible blades included
- Includes bowl light fixture with three 60-watt candelabra incandescent bulbs
- 172 x 20 motor

*Tip*  
Create a one-of-a-kind Academy with Custom Casablanca (page 17)

## ACADEMY GALLERY



### MOTOR & BLADE FINISHES



A



B

#### A: 54080

Bronze Patina motor with reversible Burnt Walnut / Walnut blades and Cased White glass

#### B: 54081

Antique Pewter motor with reversible Espresso / Smoked Walnut blades and Cased White glass

### CONTROLS



**Included**  
4-Speed Pullchain



**99019 (optional)**  
Universal Control System  
Four-speed remote control and receiver with full-range light dimming and CFL mode.

### DIMENSIONS AND ENERGY INFORMATION (AT HIGH SPEED)

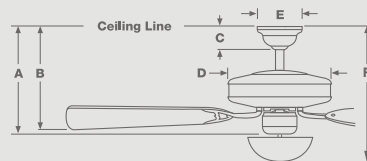

Dimensions	Airflow
A: 13.11"	6,546 cfm
B: 10.95"	Electricity Use
C: 2.75"	80-watt
D: 13.72"	Airflow Efficiency
E: 6.49"	82 cfm/watt
F: 18.32"	



## 64395 (C18G500F)

Aged Bronze motor with outdoor carved featherwood blades in Reclaimed Antique

Make a statement of graceful refinement on a grand scale with the damp-rated Atria® ceiling fan. The faux alabaster motor housing includes an uplight and a downlight that illuminates the entire fan body with a warm, ambient glow.

### FEATURES

- XTR200™ 30mm motor / lifetime motor warranty
- ETL rated for damp or humid locations
- 68" blade span
- Set of 5 exclusive outdoor carved featherwood blades included
- Integrated 120-watt uplight with eight 15-watt bulbs included
- Integrated 100-watt downlight with two 50-watt T4 halogen bulbs included
- Requires additional hanging support (included)
- 200 x 30 motor
- Minimum 9' ceiling required

*Discontinued - while supplies last*

ATRIA®



### MOTOR & BLADE FINISHES



A

### A: 64395 (C18G500F)

Aged Bronze motor with outdoor carved featherwood blades in Reclaimed Antique

### CONTROLS



#### Included

W-81

Four-speed wall control with full-range light dimming. No reversing function.

### DIMENSIONS AND ENERGY INFORMATION (AT HIGH SPEED)

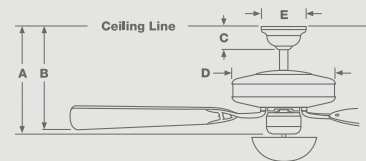

Dimensions	Airflow
A: 28.80"	9,042 cfm
B: 23.40"	Electricity Use
C: 3.00"	93-watt
D: 17.10"	Airflow Efficiency
E: 5.60"	97 cfm/watt
F: -	

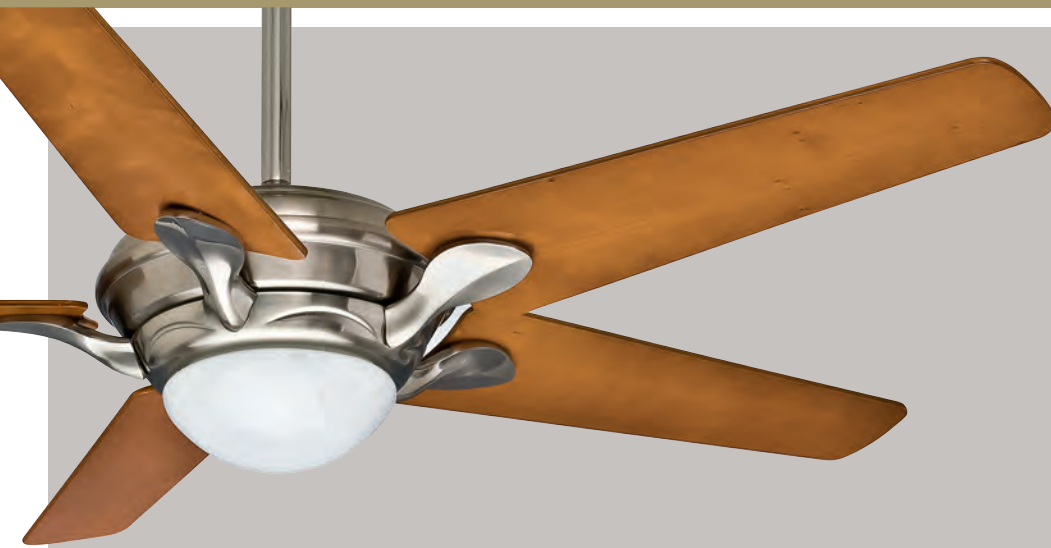

## 59076

Brushed Nickel motor with Cherrywood blades and Cased White glass

The popular Bel Air® is the essence of Casablanca beauty. The housing and integrated halogen light form a streamlined design that creates a compelling and sophisticated presence. Uniquely cast blade holders lend a classic yet transitional look.

### FEATURES

- Direct Drive™ motor / lifetime motor warranty
- 56" blade span
- Set of 5 exclusive blades included
- Integrated 100-watt downlight with one T4 halogen bulb included
- 188 x 20 motor

BEL AIR®



BLADES  
included

### MOTOR & BLADE FINISHES



A



B



C

#### A: 59076

Brushed Nickel motor with Cherrywood veneer blades and Cased White glass

#### B: 59077

Snow White motor with Snow White blades and Cased White glass

#### C: 59078

Brushed Cocoa motor with Walnut veneer blades and Cased White glass

### CONTROLS



#### Included

Universal Control  
Four-speed wall control with full-range light dimming, reversing and CFL mode.



#### 99020 (optional)

Universal Remote  
Four-speed remote control with full-range light dimming, reversing and CFL mode.

### DIMENSIONS AND ENERGY INFORMATION (AT HIGH SPEED)

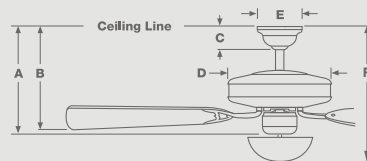

Dimensions	Airflow
A: —	7,133 cfm
B: 9.86"	Electricity Use
C: 2.75"	86-watt
D: 12.19"	Airflow Efficiency
E: 6.49"	83 cfm/watt
F: 14.29"	



59114

Maiden Bronze motor with Smoked Walnut All-Weather blades and Cased White glass

Damp-rated with an imaginative style, this outdoor model features a unique, integrated halogen light that is sure to be the focus of any room. By combining a nautical theme with an industrial edge, the Caneel Bay has a look that is entirely its own.

FEATURES

- Direct Drive™ motor / lifetime motor warranty
- 56" blade span
- Set of 5 blades included
- Includes 6" downrod
- 188 x 20 motor
- Integrated light kit with two 50-watt halogen bulbs included
- ETL rated for damp or humid locations

CANEEL BAY



BLADES included



DAMP RATED

MOTOR & BLADE FINISHES



A



B

A: 59113

Aged Steel motor with White Washed Distressed Oak All-Weather blades and Cased White glass

B: 59114

Maiden Bronze motor with Smoked Walnut All-Weather blades and Cased White glass

CONTROLS



**Included**  
 Universal Control  
 Four-speed wall control with full-range light dimming, reversing and CFL mode.



**99020 (optional)**  
 Universal Remote  
 Four-speed remote control with full-range light dimming, reversing and CFL mode.

DIMENSIONS AND ENERGY INFORMATION (AT HIGH SPEED)

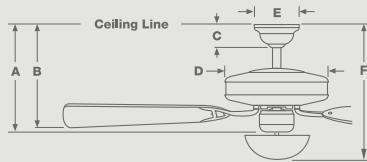

Dimensions	Airflow
A: -	6,585 cfm
B: 13.04"	Electricity Use
C: 2.75"	87-watt
D: 10.03"	Airflow Efficiency
E: 6.49"	75 cfm/watt
F: 16.79"	



## 55035

Brushed Cocoa motor with Walnut Regal-Style hand-carved wood blades

A 60-inch blade span makes this edition of the Fellini® ideal for a wide variety of rooms. Hand-carved wood blades enrich the fan's character, and subtle finishing touches are pleasantly understated.

### FEATURES

- Direct Drive™ motor / lifetime motor warranty
- 60" blade span
- Set of 5 exclusive hand-carved wood blades included
- Set of 5 intricately detailed blade medallions included
- 188 x 20 motor
- Light kits sold separately

FELLINI®



### MOTOR & BLADE FINISHES



A

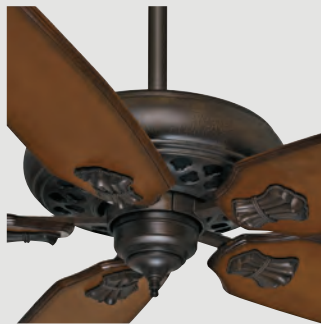

B

#### A: 55035

Brushed Cocoa motor with Walnut Regal-Style hand-carved wood blades

#### B: 55036

Provence Crackle motor with Aged Oak hand-carved wood blades

### CONTROLS



#### Included

Universal Control  
Four-speed wall control with full-range light dimming, reversing and CFL mode.



#### 99020 (optional)

Universal Remote  
Four-speed remote control with full-range light dimming, reversing and CFL mode.

### LIGHTING

Our design team's recommended lighting option.

#### 99105

Four-Light Fitter in Brushed Cocoa



#### 99044

2 1/4" Side Glass with Ribbed Deco Shape in Cased White

For all other compatible light fixtures, see pages 127-130.

### DIMENSIONS AND ENERGY INFORMATION (AT HIGH SPEED)

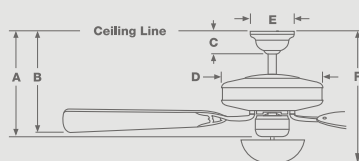

#### Dimensions

- A: 14.96"  
B: 12.50"  
C: 2.75"  
D: 14.20"  
E: 6.49"  
F: -

#### 55035

Airflow  
5,148 cfm

Electricity Use  
55-watt

Airflow Efficiency  
94 cfm/watt

#### 55036

Airflow  
5,057 cfm

Electricity Use  
54-watt

Airflow Efficiency  
93 cfm/watt



## 59518

Provence Crackle motor with Distressed Walnut / Dark Walnut veneer blades

With the classic, understated look of the Fellini®, the Fellini® DC boasts a powerful DC motor, a 66-inch blade span, and a DC 6-speed fan control. The fan is ideal for a wide variety of rooms.

### FEATURES

- DC-165 motor / lifetime motor warranty
- 66" blade span
- Set of 5 exclusive blades included
- Set of 5 intricately detailed blade medallions included
- Light kits sold separately

FELLINI® DC



### MOTOR & BLADE FINISHES



A

### A: 59518

Provence Crackle motor with Distressed Walnut / Dark Walnut veneer blades

### CONTROL



#### Included

DC 6-speed

Six-speed control with full-range light dimming and reversing.

### LIGHTING

Our design team's recommended lighting option.



#### 99104

Four-Light Fitter in Provence Crackle

#### 99045

2 1/4" Side Glass with Ribbed Deco Shape in Toffee

For all other compatible light fixtures, see pages 127-130.

### DIMENSIONS AND ENERGY INFORMATION (AT HIGH SPEED)

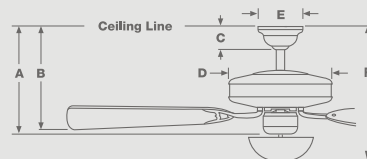

#### Dimensions

A:	15.13"
B:	11.88"
C:	2.75"
D:	14.20"
E:	6.49"
F:	-

#### Airflow

8,651 cfm

Electricity Use  
35-watt

Airflow Efficiency  
249 cfm/watt



## 59163

Metallic Birch motor with Weathered Grey Veneer blades and Cased White Glass

Inspired by Japanese woodwork, the repeated louvers around the light kit are the centerpiece of the Glen Arbor's composition. The metallic finishes combine with the outstanding wood features to result in a look that is both glamorous and natural.

### FEATURES

- Direct Drive™ motor / lifetime motor warranty
- 56" blade span
- Set of 3 blades included
- 3" and 2" downrods included
- Includes integrated light kit with two 9.8-watt LED bulbs
- 172 x 20 motor

## GLEN ARBOR



### MOTOR & BLADE FINISHES



A



B

#### A: 59162

Metallic Chocolate motor with Weathered Timber Veneer blades and Cased White Glass

#### B: 59163

Metallic Birch motor with Weathered Grey Veneer blades and Cased White Glass

### CONTROLS



#### Included

Universal Remote  
Four-speed remote control with full-range light dimming and reversing.

### LIGHTING

Includes dimmable LED light kit.



#### Base:

Medium (A19)

#### Wattage:

9.8 watts each

#### LED Light Output:

800 lumens each

#### Correlated Color Temperature (CCT):

3000K

### DIMENSIONS AND ENERGY INFORMATION (AT HIGH SPEED)

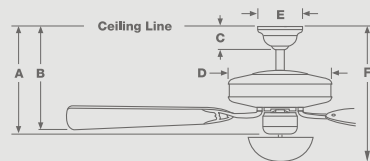

#### Dimensions

A:	-
B:	8.94"
C:	2.75"
D:	8.73"
E:	6.49"
F:	17.70"

#### Airflow

6,600 cfm

#### Electricity Use

80-watt

#### Airflow Efficiency

82 cfm/watt





*Share*

Share your design  
for a chance  
to be  
featured using  
#casablancafano



## 55051

Aged Steel motor with outdoor carved featherwood blades in Mountain Timber

Inspired by the latest high-end furniture trends, the Heathridge's body has the appearance of turned wood that complements its solid wood blades. Simple, sophisticated and perfect for updating any room.

### FEATURES

- Direct Drive™ motor / lifetime motor warranty
- 60" blade span
- Set of 5 solid featherwood blades
- 188 x 20 motor
- Includes four-light fitter with four 40-watt candelabra incandescent bulbs
- ETL rated for damp or humid locations

# HEATHRIDGE



### MOTOR & BLADE FINISHES



A



B

#### A: 55051

Aged Steel motor with outdoor carved featherwood blades in Mountain Timber and Sepia glass

#### B: 55052

Tahoe motor with outdoor carved featherwood blades in River Timber and Sepia glass

### CONTROLS



#### Included

Universal Control  
Four-speed wall control with full-range light dimming, reversing and CFL mode.



#### 99020 (optional)

Universal Remote  
Four-speed remote control with full-range light dimming, reversing and CFL mode.

### DIMENSIONS AND ENERGY INFORMATION (AT HIGH SPEED)

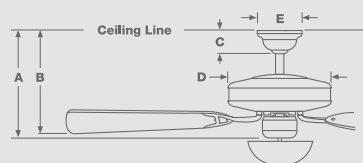

Dimensions	
A:	13.12"
B:	11.76"
C:	2.75"
D:	15.21"
E:	6.49"
F:	20.32"

Airflow	6,191 cfm
Electricity Use	87-watt
Airflow Efficiency	70 cfm/watt



## 59527

Aged Bronze motor with outdoor carved featherwood blades in Reclaimed Antique

During the Industrial Revolution, innovations in manufacturing enabled artisans to create furniture from cast iron. The Heritage™ incorporates many of the design details featured in antique castings from this era. The fan features vertical ribbing on its motor housing, raised type on the switch cap, and a custom cobblestone texture on the fan body, cap, and inset portions of the blade medallions.

### FEATURES

- Direct Drive™ / lifetime motor warranty
- 60" blade span
- Set of 5 exclusive outdoor blades
- Moisture-resistant motor and enclosed housing
- Stainless steel hardware
- 188 x 20 motor
- Light kits sold separately
- ETL rated for wet locations

HERITAGE™



### MOTOR & BLADE FINISHES



A



B

#### A: 59527

Aged Bronze motor with outdoor carved featherwood blades in Reclaimed Antique

#### B: 59528

Brushed Cocoa motor with outdoor carved featherwood blades in Reclaimed Antique

### CONTROLS



**Included**  
4-Speed Pullchain



**99019 (optional)**  
Universal Control System  
Four-speed remote control and receiver with full-range light dimming and CFL mode.

### LIGHTING

Our design team's recommended lighting option.



**99087**  
Outdoor Four-Light Fixture in Aged Bronze

For all other compatible light fixtures, see pages 127-130.

### DIMENSIONS AND ENERGY INFORMATION (AT HIGH SPEED)

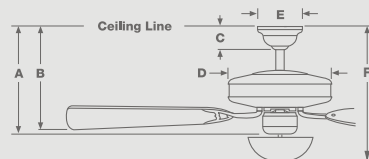

Dimensions	
A:	13.02"
B:	11.97"
C:	2.75"
D:	15.96"
E:	6.49"
F:	-

Airflow	
	6,865 cfm
Electricity Use	
	82-watt
Airflow Efficiency	
	84 cfm/watt



## 59536

Bronze Patina motor with Walnut / Burnt Walnut veneer blades and Amber Rain glass

The Holliston™ Gallery ceiling fan combines classical styling with the ultimate in performance and convenience. This fan comes furnished with an elegant four-light fitter and universal wall control, offering a full range of lighting options.

### FEATURES

- Direct Drive™ motor / lifetime motor warranty
- 60" blade span
- Set of 5 blades included
- Includes four-light fitter with four 14-watt medium-based CFL bulbs
- 188 x 20 motor

*Tip*  
Create a one-of-a-kind Holliston with Custom Casablanca (page 27)

## HOLLISTON™ GALLERY



### MOTOR & BLADE FINISHES



A



B

#### A: 59536

Bronze Patina motor with Walnut / Burnt Walnut veneer blades and Amber Rain glass

#### B: 59537

Bullion Black motor with Reclaimed Antique veneer blades and Cased White glass

### CONTROLS



#### Included

Universal Control  
Four-speed wall control with full-range light dimming, reversing and CFL mode.



#### 99020 (optional)

Universal Remote  
Four-speed remote control with full-range light dimming, reversing and CFL mode.

### DIMENSIONS AND ENERGY INFORMATION (AT HIGH SPEED)

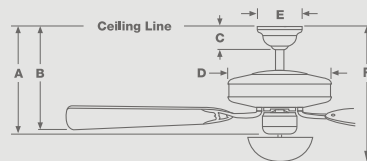

#### Dimensions

- A: 12.47"
- B: 10.50"
- C: 2.75"
- D: 13.94"
- E: 6.49"
- F: 19.94"

Airflow  
6,369 cfm

Electricity Use  
88-watt

Airflow Efficiency  
72 cfm/watt



## 54036

Aged Bronze motor with Dark Walnut All-Weather Blades

The versatile Utopian® fan is ideally suited for humid environments. Smooth contours and simple lines provide a clean, progressive look that enhances décor without distraction. For bathrooms, kitchens, and verandas, the Utopian® is the perfect choice.

### FEATURES

- Direct Drive™ motor / lifetime motor warranty
- 52" blade span
- Set of 5 blades included
- Select models ETL rated for damp or humid locations
- 172 x 20 motor
- Light kits sold separately

UTOPIAN®



### MOTOR & BLADE FINISHES



A

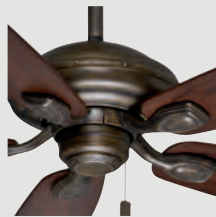

B



C



D

#### A: 54035

Brushed Cocoa motor with Distressed Antique Halifax All-Weather blades

#### B: 54036

Aged Bronze motor with Dark Walnut All-Weather blades

#### C: 54037

Snow White motor with Matte Snow White All-Weather blades

#### D: 54038

Brushed Nickel motor with reversible Walnut / Burnt Walnut blades.

*This finish is not damp rated.*

### CONTROLS



**Included**  
4-Speed Pullchain



**99019 (optional)**  
Universal Control System  
Four-speed remote control and receiver with full-range light dimming and CFL mode.

### LIGHTING

Our design team's recommended lighting option.



**99087**  
Outdoor Four-Light Fixture in Aged Bronze

For all other compatible light fixtures, see pages 127-130.

### DIMENSIONS AND ENERGY INFORMATION (AT HIGH SPEED)

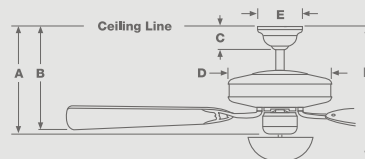

#### Dimensions

A:	12.86"
B:	11.64"
C:	2.75"
D:	11.24"
E:	6.49"
F:	-

Airflow  
**6,424 cfm**

Electricity Use  
**81-watt**

Airflow Efficiency  
**79 cfm/watt**



## 54039

Brushed Cocoa motor with Distressed Antique Halifax All-Weather blades and Tea Stain glass

With a clean, progressive design, it has everything that is attractive about the Utopian® fan but adds a bowl light and four-speed wall-mount control. It is ideal for humid environments.

### FEATURES

- Direct Drive™ motor / lifetime motor warranty
- 52" blade span
- Set of 5 blades included
- Includes bowl light fixture with three 60-watt candelabra incandescent bulbs
- Select models ETL rated for damp or humid locations
- 172 x 20 motor

## UTOPIAN® GALLERY



### MOTOR & BLADE FINISHES



A



B



C



D

#### A: 54039

Brushed Cocoa motor with Distressed Antique Halifax All-Weather blades and Tea Stain glass

#### B: 54040

Aged Bronze motor with Dark Walnut All-Weather blades and Champagne Scavo glass

#### C: 54041

Snow White motor with Matte Snow White All-Weather blades and Cased White glass

#### D: 54042

Brushed Nickel with reversible Walnut / Burnt Walnut blades and Cased White glass

*This finish is not damp rated.*

### CONTROLS



#### Included

Universal Control  
Four-speed wall control with full-range light dimming, reversing and CFL mode.



#### 99020 (optional)

Universal Remote  
Four-speed remote control with full-range light dimming, reversing and CFL mode.

### DIMENSIONS AND ENERGY INFORMATION (AT HIGH SPEED)

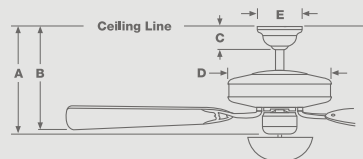

#### Dimensions

A:	12.86"
B:	11.64"
C:	2.75"
D:	11.24"
E:	6.49"
F:	18.33"

Airflow  
6,504 cfm

Electricity Use  
84-watt

Airflow Efficiency  
77 cfm/watt



## 59062

Antique Pewter motor with Rosewood ABS blades and Cased White glass

With its versatile design and quality craftsmanship, the Whitman™ ceiling fan brings year-round comfort and seamless performance to any room in the home. The fan incorporates artfully designed blades that are reminiscent of the woodwork on fine cabinetry and a fully dimmable uplight and downlight that adds gentle ambience to your room.

### FEATURES

- Direct Drive™ motor / lifetime motor warranty
- 54" blade span
- Set of 5 blades included
- Set of 5 intricately detailed blade medallions included
- Integrated 75-watt incandescent uplight with five 15-watt bulbs included
- Integrated 100-watt downlight with two 50-watt T4 halogen bulbs included
- 172 x 20 motor

*Discontinued - while supplies last*

WHITMAN™



BLADES  
included

### MOTOR & BLADE FINISHES



A



B



C

#### A: 59059

Brushed Nickel motor with Reclaimed Antique carved wood blades and Cased White glass

#### B: 59061

Bronze Patina motor with Walnut carved wood blades and Cased White glass

#### C: 59062

Antique Pewter motor with Rosewood ABS blades and Cased White glass

### CONTROLS



#### Included

Universal Control  
Four-speed wall control with full-range light dimming, reversing and CFL mode.



#### 99020 (optional)

Universal Remote  
Four-speed remote control with full-range light dimming, reversing and CFL mode.

### DIMENSIONS AND ENERGY INFORMATION (AT HIGH SPEED)

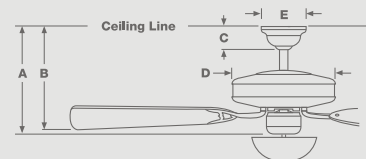

#### Dimensions

A:	-
B:	11.54"
C:	2.75"
D:	13.10"
E:	6.49"
F:	17.00"

Airflow  
6,693 cfm

Electricity Use  
84-watt

Airflow Efficiency  
79 cfm/watt



K0062-02	3	#6-32 RHMS, W/ SEMS
K0063-02	2	1/4-20 SQHSS, CUP POINT
K0064-04	6	1/4-20 PHHCS, W/ SPLIT LOCK
K0071-47	1	ASSEMBLY, TRILOBE DOWNROD
K0097-01	1	CONNECTOR, MALE PIN
K0098-01	1	MALE HOUSING, SINGLE PLUG
K0099-01	1	CONNECTOR, FEMALE PIN
K0100-01	1	FEMALE HOUSING, SINGLE PLUG
K0113-01	1	CAUTION TAG, SET SCREW
K0116-03	1	WIRE SCHEMATIC, CONTROL FAN
K0118-01	1	BALANCE KIT, UNIVERSAL
K0119-01	1	#6-32 THMS, W/O SEMS

- B N
- B C
- Q R
- C D
- N
- N
- N
- N
- NOT SHOWN B G
- NOT SHOWN

K2952-01	1	
K2953-03	1	
K2956-01	1	
K2957-01	1	
K4284-02	1	
K5543-02	1	CASA SOFT
K5616-01	1	UPPER
K5618-01	1	
K5844-01	1	
M8536-01	1	



SCALE 1:8

G: GENERAL  
 I: MUST COMPLY WITH GENERAL CEILING FAN SPECIFICATIONS  
 J: MUST COMPLY WITH GENERAL CEILING FAN PACKAGING  
 K: MUST COMPLY WITH GENERAL CEILING FAN SPECIFICATIONS F4045  
 L: REQUIRED SHIPPING RETAINING TO BE DETERMINED

# ORCHID CEILING FAN





# CONTEMPORARY





## 59123

Brushed Nickel motor with Mayse All-Weather blades

Clean and simple design that appeals to the senses. Wood-tone finishes dipped in film put the exclamation point on this contemporary model.

### FEATURES

- Direct Drive™ motor / lifetime motor warranty
- 54" blade span
- Set of 4 exclusive blades included
- 172 x 20 motor
- Light kits sold separately
- ETL rated for damp or humid locations

ARIS



### MOTOR & BLADE FINISHES



A

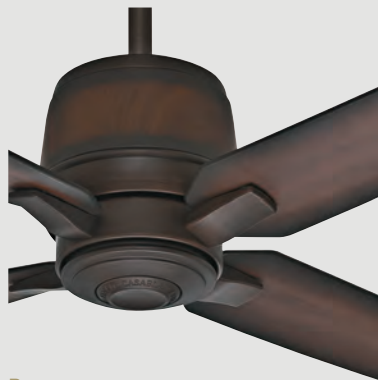

B

#### A: 59123

Brushed Nickel motor with Mayse All-Weather blades

#### B: 59124

Brushed Cocoa motor with Burnished Mahogany All-Weather blades

### CONTROLS



#### Included

Universal Control  
Four-speed wall control with full-range light dimming, reversing and CFL mode.



#### 99020 (optional)

Universal Remote  
Four-speed remote control with full-range light dimming, reversing and CFL mode.

### DIMENSIONS AND ENERGY INFORMATION (AT HIGH SPEED)

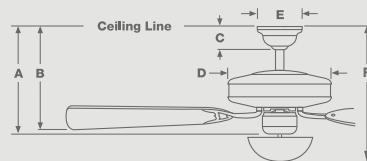

Dimensions	Airflow
A: 14.69"	6,196 cfm
B: 12.78"	Electricity Use
C: 2.75"	82-watt
D: 8.74"	Airflow Efficiency
E: 6.49"	75 cfm/watt
F: -	



# BULLET



**BLADES**  
included

## 59068

Brushed Nickel motor with reversible  
Burnt Walnut / Walnut veneer blades  
and Cased White glass

Drawing influence from 21st century skyscrapers, the Bullet combines function and sophistication in a way that only Casablanca can. The rounded elements collaborate to create a stacking effect atop a beautiful beacon of light. This minimalist design is perfect for spacious lofts or practically any modern space you choose.

### FEATURES

- Direct Drive™ motor / lifetime motor warranty
- 54" blade span
- Set of 4 exclusive blades included
- Includes 2.5" and 12" downrods
- Integrated 100-watt downlight with one R7S halogen bulb included
- Minimum 9' ceiling required when using downrod cover
- 172 x 20 motor

### MOTOR & BLADE FINISHES



A



B



C

#### A: 59068

Brushed Nickel motor with reversible  
Burnt Walnut / Walnut veneer blades  
and Cased White glass

#### B: 59069

Brushed cocoa motor with reversible  
Burnt Walnut / Walnut veneer blades  
and Frosted Pearl glass

#### C: 59070

Snow White motor with Snow White blades  
and Cased White glass

### CONTROLS



#### Included

**Universal Control**  
Four-speed wall control with  
full-range light dimming,  
reversing and CFL mode.



#### 99020 (optional)

**Universal Remote**  
Four-speed remote control  
with full-range light dimming,  
reversing and CFL mode.

### DIMENSIONS AND ENERGY INFORMATION (AT HIGH SPEED)

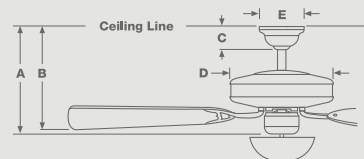

#### Dimensions

A:	-
B:	20.86"
C:	2.75"
D:	8.08"
E:	6.49"
F:	24.03"

Airflow  
**6,487** cfm

Electricity Use  
**84**-watt

Airflow Efficiency  
**77** cfm/watt



## 59197

Brushed Nickel motor with Champagne blades and Cased White Glass

Inspired by Scandinavian design, the minimal metal and glass elements add just the right amount of subtlety to offer an intimate sensibility that will blend with a variety of home decor.

### FEATURES

- Direct Drive™ motor / lifetime motor warranty
- 56" blade span
- Set of 5 blades included
- 3" and 2" downrods included
- Integrated LED light kit
- 172 x 20 motor

# CORRENE



### MOTOR & BLADE FINISHES



A



B

#### A: 59197

Brushed Nickel motor with Champagne blades and Cased White Glass

#### B: 59198

Brushed nickel motor with Coffee Beech blades and Cased White Glass

### CONTROLS



#### Included

Universal Remote  
Four-speed remote control with full-range light dimming and reversing.

### LIGHTING

Includes dimmable LED light kit.



#### Base:

Integrated LED

#### Wattage:

17 watts

#### LED Light Output:

1500 lumens

#### Correlated Color Temperature (CCT):

2700K

### DIMENSIONS AND ENERGY INFORMATION (AT HIGH SPEED)

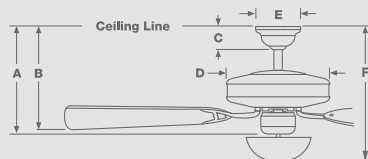

#### Dimensions

A:	–
B:	10.19"
C:	2.75"
D:	11.42"
E:	6.49"
F:	13.50"

#### Airflow

7,152 cfm

#### Electricity Use

86-watt

#### Airflow Efficiency

84 cfm/watt

*Share*

Share your design  
for a chance  
to be  
featured using  
#casablancafano



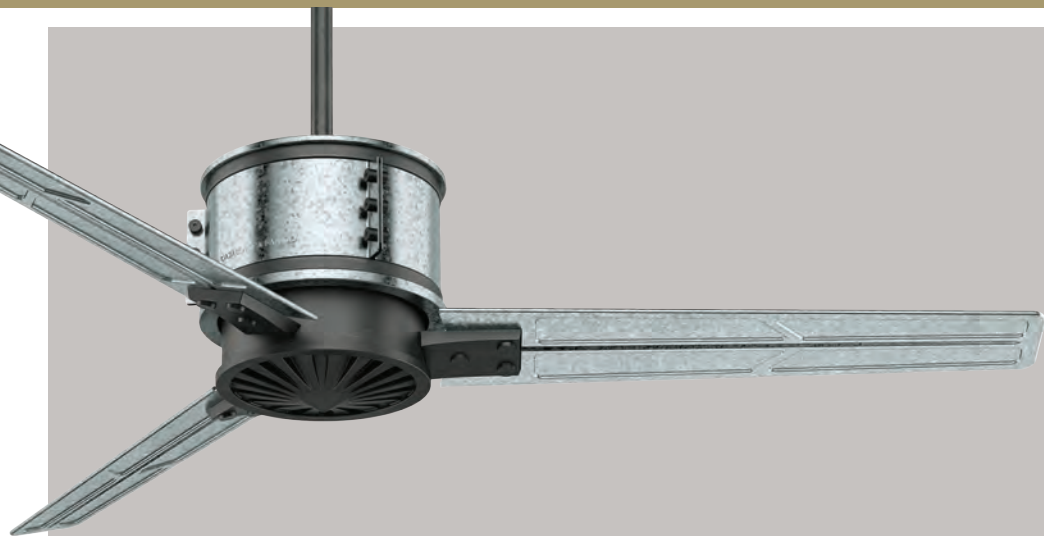

## 59191

Galvanized Steel / Aged Steel motor with Galvanized Steel blades

Boasting purely industrial aesthetics from top to bottom, this fan carries a certain grace and ease that allows it to blend right in to any loft or contemporary environment.

### FEATURES

- Direct Drive™ motor / lifetime motor warranty
- 60" blade span
- Set of 3 blades included
- 11" downrod included
- Minimum 9' ceiling required
- Select models ETL rated for damp or humid locations
- 212 x 35 motor

## DULUTH 60"



FRESH WHITE ONLY

### MOTOR & BLADE FINISHES

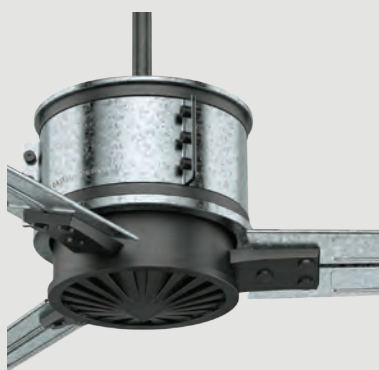

A



B

#### A: 59191

Galvanized Steel / Aged Steel motor with Galvanized Steel blades

#### B: 59192

Fresh White / Granite motor with Fresh White blades

### CONTROLS



#### Included

Stepped Wall Control  
Three-speed wall control.

### DIMENSIONS AND ENERGY INFORMATION (AT HIGH SPEED)

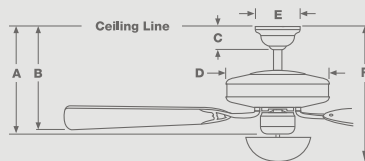

Dimensions†	Airflow
A: 22.32"	7,988 cfm
B: 21.46"	Electricity Use
C: 2.75"	113-watt
D: 10.67"	Airflow Efficiency
E: 6.49"	71 cfm/watt
F: -	

†with 11" downrod (included)

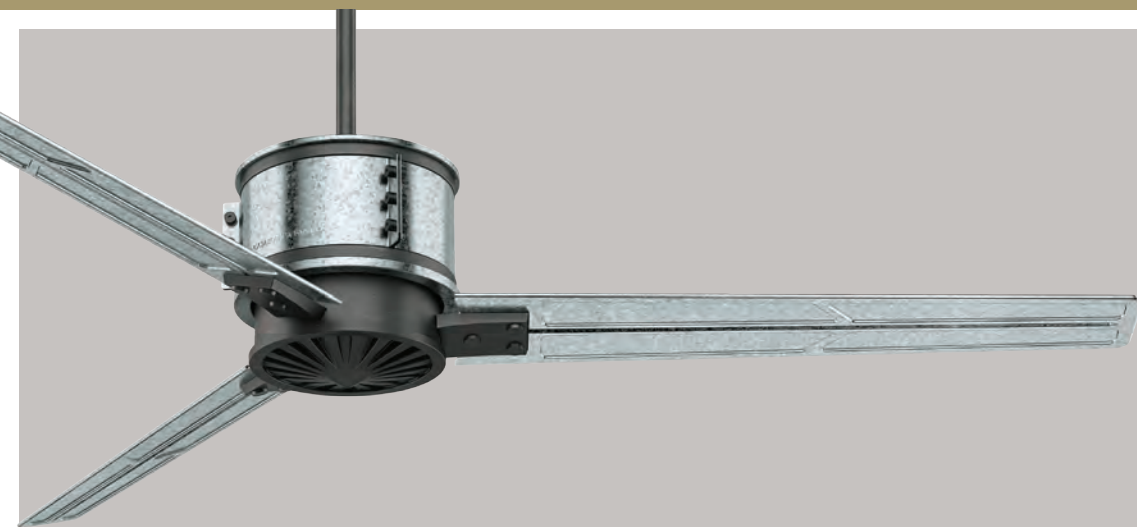

## 59193

Galvanized Steel / Aged Steel motor with Galvanized Steel blades

Boasting purely industrial aesthetics from top to bottom, this fan carries a certain grace and ease that allows it to blend right in to any loft or contemporary environment.

### FEATURES

- Direct Drive™ motor / lifetime motor warranty
- 72" blade span
- Set of 3 blades included
- 11" downrod included
- Minimum 9' ceiling required
- Select models ETL rated for damp or humid locations
- 212 x 35 motor

## DULUTH 72"



FRESH WHITE ONLY

### MOTOR & BLADE FINISHES

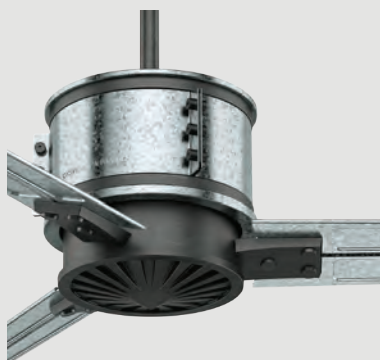

A



B

#### A: 59193

Galvanized Steel / Aged Steel motor with Galvanized Steel blades

#### B: 59194

Fresh White / Granite motor with Fresh White blades

### CONTROLS



**Included**  
Stepped Wall Control  
Three-speed wall control.

### DIMENSIONS AND ENERGY INFORMATION (AT HIGH SPEED)

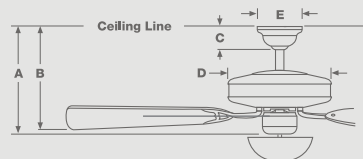

Dimensions*	Airflow	Electricity Use	Airflow Efficiency
A: 22.32"	9,475 cfm	110-watt	86 cfm/watt
B: 21.46"			
C: 2.75"			
D: 10.67"			
E: 6.49"			
F: -			

\*with 11" downrod (included)



## 59137

Pewter Revival motor with Architectural White blades and Cased White Glass

Inspired by the flower, a delicate balance between softness and rigidity elevates this fan to a level of charm rarely achieved by such a simple design.

### FEATURES

- Direct Drive™ motor / lifetime motor warranty
- 30" blade span
- Set of 3 blades included
- 12" downrod included
- Minimum 9' ceiling required
- ETL rated for damp or humid locations
- Integrated LED light kit
- 172 x 12 motor

ORCHID



### MOTOR & BLADE FINISHES



A



B

#### A: 59137

Pewter Revival motor with Architectural White blades and Cased White Glass

#### B: 59138

Pewter Revival motor with Walnut blades and Cased White Glass

### CONTROLS



#### Included

Universal Control  
Four-speed wall control with full-range light dimming, reversing and CFL mode.



#### 99020 (optional)

Universal Remote  
Four-speed remote control with full-range light dimming, reversing and CFL mode.

### LIGHTING

Includes dimmable LED light kit.



#### Base:

Integrated LED

#### Wattage:

23 watts

#### Bulb Light Output:

2200 lumens

#### Correlated Color Temperature (CCT):

2700K

### DIMENSIONS AND ENERGY INFORMATION (AT HIGH SPEED)

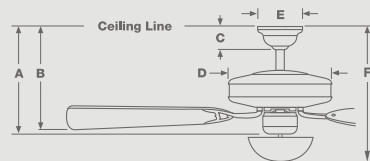

#### Dimensions\*

- A: —
- B: 21.05"
- C: 2.75"
- D: 11.14"
- E: 6.49"
- F: 23.74"

Airflow  
2,855 cfm

Electricity Use  
56-watt

Airflow Efficiency  
51 cfm/watt

\*with 12" downrod (included)





*Share*  
Share your design  
for a chance  
to be  
featured using  
#casablancafanco



## 59168

Metallic SunSand motor with Drift Oak blades and Cased White Glass

Formal yet contemporary is a difficult balance to find, but the Perseus is a shining example. Named after the star constellation, this piece is inspired by 21st-century spacecraft design. The floating ring around the fan is something otherworldly, and this cosmic approach is carried throughout the design. The interplay between the earthly wood blades and the celestial metallic body is not quite like anything the world has seen before.

### FEATURES

- Direct Drive™ motor / lifetime motor warranty
- 64" blade span
- Set of 3 blades included
- 12" and 5" downrods included
- ETL rated for damp or humid locations
- Integrated LED light kit
- 188 x 20 motor

NEW

PERSEUS



### MOTOR & BLADE FINISHES



A



B

#### A: 59167

Brushed Nickel motor with Walnut blades and Cased White Glass

#### B: 59168

Metallic SunSand motor with Drift Oak blades and Cased White Glass

### DOWNROD SLEEVES

#### Walnut Finish

- 99321 14.5" sleeve for 18" downrod
- 99322 20.5" sleeve for 24" downrod
- 99323 32.5" sleeve for 36" downrod

#### Drift Oak Finish

- 99324 14.5" sleeve for 18" downrod
- 99325 20.5" sleeve for 24" downrod
- 99326 32.5" sleeve for 36" downrod

### LIGHTING

Includes dimmable LED light kit.

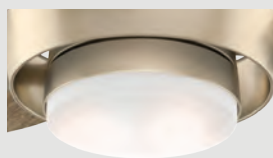

#### Base:

Integrated LED

#### Wattage:

23 watts

#### LED Light Output:

2200 lumens

#### Correlated Color Temperature (CCT):

2700K

### CONTROLS



#### Included

Universal Control  
Four-speed wall control with full-range light dimming, reversing and CFL mode.



#### 99020 (optional)

Universal Remote  
Four-speed remote control with full-range light dimming, reversing and CFL mode.

### DIMENSIONS AND ENERGY INFORMATION (AT HIGH SPEED)

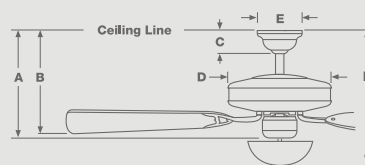

#### Dimensions\*

A:	—	Airflow	7,374 cfm
B:	18.26"	Electricity Use	88-watt
C:	2.75"	Airflow Efficiency	84 cfm/watt
D:	14.60"		
E:	6.49"		
F:	22.67"		

\*with 12" downrod (included)

FOR ALL THINGS  
DESIGN,  
FOLLOW US ON



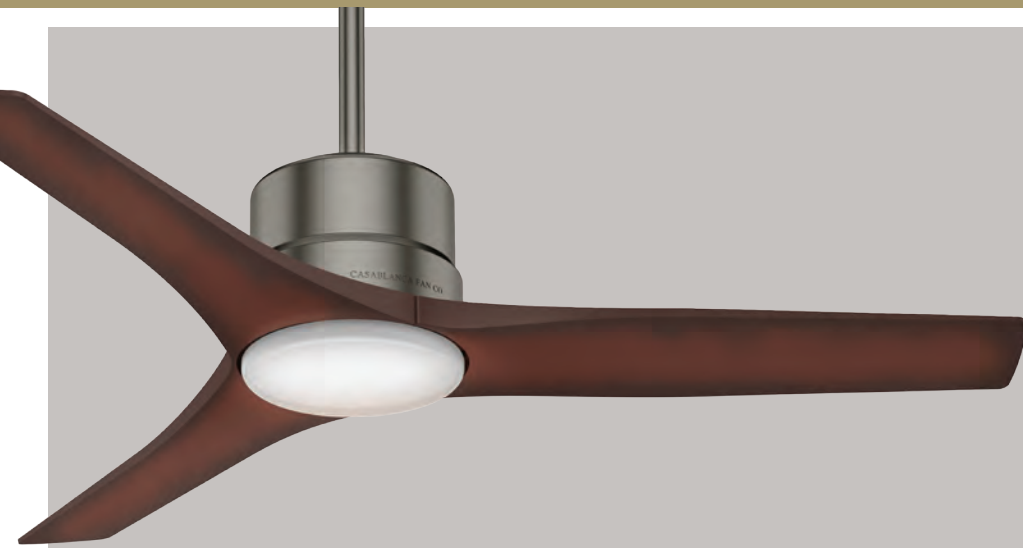

## 59195

Brushed Slate motor with Coffee Beech All-Weather Blades and Cased White Glass

Taking cues from the early American Industrial Age, the clean lines and slick finishes combine with the mid-century blade design to provide a look that is undoubtedly modern.

### FEATURES

- Direct Drive™ motor / lifetime motor warranty
- 52" blade span
- Set of 3 blades included
- 3" and 2" downrods included
- Integrated LED light kit
- ETL rated for damp or humid locations
- 172 x 20 motor

PISTON



### MOTOR & BLADE FINISHES



A



B

#### A: 59195

Brushed Slate motor with Coffee Beech All-Weather Blades and Cased White Glass

#### B: 59196

Matte Black motor with Matte Black All-Weather Blades and Cased White Glass

### CONTROLS



#### Included

Universal Remote  
Four-speed remote control with full-range light dimming.

### LIGHTING

Includes dimmable LED light kit.



#### Base:

Integrated LED

#### Wattage:

17 watts

#### LED Light Output:

1500 lumens

#### Correlated Color Temperature (CCT):

2700K

### DIMENSIONS AND ENERGY INFORMATION (AT HIGH SPEED)

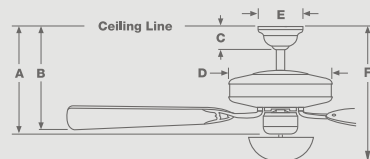

#### Dimensions

A:	—
B:	12.97"
C:	2.75"
D:	8.66"
E:	6.49"
F:	13.56"

#### Airflow

5,549 cfm

#### Electricity Use

82-watt

#### Airflow Efficiency

68 cfm/watt



FOR ALL THINGS  
DESIGN,  
FOLLOW US ON





## 59121

Snow White motor with Snow White blades and Clear Frosted glass

The Riello is an artistic, contemporary piece that takes simplicity to new heights. With no visible screws and minimal hardware, the bottom housing spins with the blades to create an illusionary hovering effect around a column of light. This awesomely simple design exudes a finesse that is sure to elicit compliments and keep your room feeling modern and fresh.

### FEATURES

- Direct Drive™ motor / lifetime motor warranty
- 60" blade span
- Set of 3 exclusive blades included
- Integrated LED light kit
- 188 x 20 motor



### MOTOR & BLADE FINISHES



A



B

#### A: 59119

Maiden Bronze motor with Walnut blades and Clear Frosted glass

#### B: 59121

Snow White motor with Snow White blades and Clear Frosted glass

### CONTROLS



#### Included

**Universal Control**  
Four-speed wall control with full-range light dimming, reversing and CFL mode.



#### 99020 (optional)

**Universal Remote**  
Four-speed remote control with full-range light dimming, reversing and CFL mode.

### LIGHTING

Includes dimmable LED light kit.



#### Base:

Integrated LED

#### Wattage:

16 watts

#### LED Light Output:

1300 lumens

#### Correlated Color Temperature (CCT):

3000K

### DIMENSIONS AND ENERGY INFORMATION (AT HIGH SPEED)

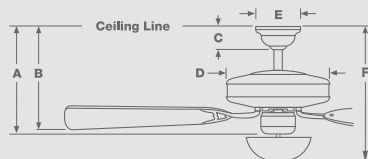

#### Dimensions

A:	—
B:	11.47"
C:	2.75"
D:	11.73"
E:	6.49"
F:	12.40"

#### Airflow

6,916 cfm

#### Electricity Use

87-watt

#### Airflow Efficiency

79 cfm/watt



## 59092

Industrial Rust motor with River Timber blades and Cased White glass

Don't let the name fool you. The Stealth® is an impeccably finished fan that is sure to get noticed. It is a new and improved version of one of our proven, contemporary designs.

### FEATURES

- Direct Drive™ motor / lifetime motor warranty
- 54" blade span
- Set of 5 exclusive blades included
- Integrated LED light kit
- 188 x 20 motor

STEALTH



### MOTOR & BLADE FINISHES



A



B



C



D

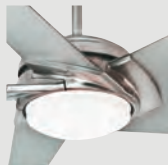

E

#### A: 59090

Brushed Nickel motor with Dark Walnut blades and Cased White glass

#### B: 59091

Snow White motor with High-Gloss Snow White blades and Cased White glass

#### C: 59092

Industrial Rust motor with River Timber blades and Cased White glass

#### D: 59093

Aged Steel motor with Grey Washed veneer blades and Cased White glass

#### E: 59094

Brushed Nickel motor with Platinum blades and Cased White glass

### CONTROLS



#### Included

Universal Control  
Four-speed wall control with full-range light dimming, reversing and CFL mode.



#### 99020 (optional)

Universal Remote  
Four-speed remote control with full-range light dimming, reversing and CFL mode.

### LIGHTING

Includes dimmable LED light kit.



#### Base:

Integrated LED

#### Wattage:

16 watts

#### LED Light Output:

1300 lumens

#### Correlated Color Temperature (CCT):

3000K

### DIMENSIONS AND ENERGY INFORMATION (AT HIGH SPEED)

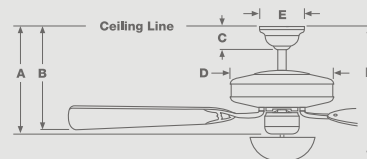

#### Dimensions

A:	—
B:	11.24"
C:	2.75"
D:	11.06"
E:	6.49"
F:	13.98"

Airflow  
6,565 cfm

Electricity Use  
90-watt

Airflow Efficiency  
73 cfm/watt



## 59107

Maiden Bronze motor with Dark Walnut blades and Cased White glass

The Stealth® DC lives up to its name by featuring our quietest motor yet. Casablanca's DC technology is extremely powerful and highly efficient—four to five times more so than other motors.

### FEATURES

- DC-165 motor / lifetime motor warranty
- 54" blade span
- Set of 5 exclusive blades included
- Integrated 100-watt downlight with one T4 halogen bulb included

STEALTH® DC



BLADES  
included

### MOTOR & BLADE FINISHES



A



B



C

#### A: 59105

Snow White motor with High-Gloss Snow White blades and Cased White glass

#### B: 59106

Brushed Nickel motor with Espresso blades and Cased White glass

#### C: 59107

Maiden Bronze motor with Dark Walnut blades and Cased White glass

### CONTROLS



#### Included

DC 6-speed

Six-speed control with full-range light dimming and reversing.

### DIMENSIONS AND ENERGY INFORMATION (AT HIGH SPEED)

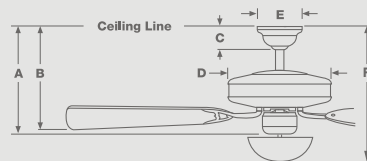

Dimensions	Airflow
A: —	6,142 cfm
B: 11.24"	Electricity Use
C: 2.75"	32-watt
D: 11.06"	Airflow Efficiency
E: 6.49"	190 cfm/watt
F: 13.98"	





## 59164

Brushed Nickel motor with Walnut veneer blades and Cased White glass

The Stealth® DC lives up to its name by featuring our quietest motor yet. Casablanca's DC technology is extremely powerful and highly efficient—four to five times more so than other motors. We then combined an already impressive fan with our industry standard ENERGY STAR® LED light kit and created what may be our most technologically impressive fan to date.

### FEATURES

- DC-165 motor / lifetime motor warranty
- 54" blade span
- Set of 5 exclusive blades included
- Integrated LED light kit

## STEALTH® DC LED



### MOTOR & BLADE FINISHES



#### A: 59164

Brushed Nickel motor with Walnut veneer blades and Cased White glass

#### B: 59165

Snow White motor with High-Gloss Snow White blades and Cased White glass

### CONTROLS



#### Included

DC 6-speed  
Six-speed control with full-range light dimming and reversing.

### LIGHTING

Includes dimmable LED light kit.



#### Base:

Integrated LED

#### Wattage:

16 watts

#### LED Light Output:

1300 lumens

#### Correlated Color Temperature (CCT):

3000K

### DIMENSIONS AND ENERGY INFORMATION (AT HIGH SPEED)

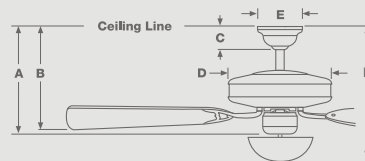

#### Dimensions

A:	—
B:	11.24"
C:	2.75"
D:	11.06"
E:	6.49"
F:	13.98"

#### Airflow

6,142 cfm

#### Electricity Use

32-watt

#### Airflow Efficiency

190 cfm/watt



## 59143

Porcelain White motor with Porcelain White Blades and Cased White glass

This fan is all about coherence and unity. With no visible screws or fasteners, the design gives a sense that every element is connected and working together seamlessly. Like a freeze-frame of aquatic motion, the Stingray appears almost weightless. The absence of accent colors and the simplicity of appearance gives you an elegant piece that is unique and uncompromising.

### FEATURES

- DC motor / lifetime motor warranty
- 60" blade span
- Set of 3 blades included
- 9" and 2" downrods included
- Integrated LED light kit
- Includes optional no-light cap



Includes optional no-light cap

## STINGRAY



### MOTOR & BLADE FINISHES



A



B

#### A: 59143

Porcelain White motor with Porcelain White blades and Cased White glass

#### B: 59144

Granite motor with Granite blades and Cased White glass

### CONTROLS



#### Included

DC 6-speed

Six-speed control with full-range light dimming and reversing.

### LIGHTING

Includes dimmable LED light kit.



#### Base:

Integrated LED

#### Wattage:

18 watts

#### LED Light Output:

1400 lumens

#### Correlated Color Temperature (CCT):

3000K

### DIMENSIONS AND ENERGY INFORMATION (AT HIGH SPEED)

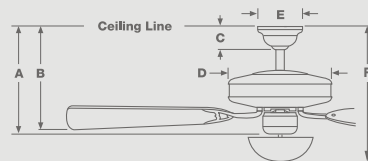

#### Dimensions\*

- A: 19.00"
- B: 18.29"
- C: 2.75"
- D: 12.62"
- E: 6.49"
- F: 19.00"

Airflow  
6,684 cfm

Electricity Use  
32-watt

Airflow Efficiency  
210 cfm/watt

\*with 9" downrod (included)



*Share*  
Share your design  
for a chance  
to be  
featured using  
#casablancafano



## 59064

Brushed Nickel motor with reversible Espresso / Walnut veneer blades and Cased White glass

Tercera™ may mean "third," but it should be first on your list for a large room. With its sleek triple-blade configuration and vintage curves, this contemporary classic combines the best of old and new.

### FEATURES

- Direct Drive™ motor / lifetime motor warranty
- 52" blade span
- Set of 3 exclusive blades included
- Includes 3.5" downrod
- Integrated 100-watt dimmable downlight with two 50-watt T4 halogen bulbs included
- 172 x 20 motor

TERCERA™



### MOTOR & BLADE FINISHES



#### A: 59064

Brushed Nickel motor with reversible Espresso / Walnut veneer blades and Cased White glass

#### B: 59065

Snow White motor with Snow White blades and Cased White glass

### CONTROLS



#### Included

Universal Control  
Four-speed wall control with full-range light dimming, reversing and CFL mode.



#### 99020 (optional)

Universal Remote  
Four-speed remote control with full-range light dimming, reversing and CFL mode.

### DIMENSIONS AND ENERGY INFORMATION (AT HIGH SPEED)

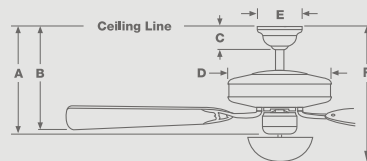

Dimensions	Airflow
A: —	6,234 cfm
B: 11.30"	Electricity Use
C: 2.75"	81-watt
D: 12.94"	Airflow Efficiency
E: 6.49"	77 cfm/watt
F: 13.71"	



## 59498

Aged Steel motor with reversible Grey Washed/River Timber veneer blades

For those who have great taste in urban design but a little less room. The 52" Tribeca delivers the sleek, modern style of the original Tribeca with a more space-friendly blade span.

### FEATURES

- Direct Drive™ motor / lifetime motor warranty
- 52" blade span
- Set of 3 exclusive reversible blades included
- Includes 7" downrod
- Minimum 9' ceiling required
- 172 x 18 motor
- Light kits sold separately

## TRIBECA 52"



### MOTOR & BLADE FINISHES



A



B



C

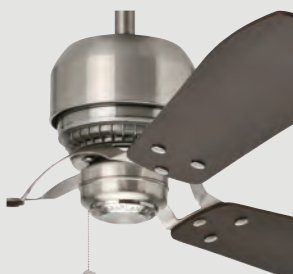

D

#### A: 59498

Aged Steel motor with reversible Grey Washed / River Timber veneer blades

#### B: 59499

Industrial Rust motor with reversible River Timber / White Washed Distressed Oak veneer blades

#### C: 59500

Snow White motor with Matte Snow White blades

#### D: 59501

Brushed Nickel motor with reversible Burnt Walnut / Walnut veneer blades

### CONTROLS



**Included**  
4-Speed Pullchain



#### 99019 (optional)

Universal Control System  
Four-speed remote control and receiver with full-range light dimming and CFL mode.

### DIMENSIONS AND ENERGY INFORMATION (AT HIGH SPEED)

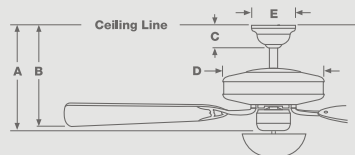

#### Dimensions

A: 17.96"  
B: 17.27"  
C: 2.75"  
D: 7.50"  
E: 6.49"  
F: -

59500  
59501

Airflow  
6,168 cfm

Electricity Use  
75-watt

Airflow Efficiency  
82 cfm/watt

59498  
59499

Airflow  
6,678 cfm

Electricity Use  
72-watt

Airflow Efficiency  
93 cfm/watt



## 59504

Brushed Nickel motor with reversible  
Burnt Walnut / Walnut veneer blades

From a loft in Soho to a gallery in Frisco, this versatile fan is at home anywhere that the love of industrially influenced urban design flourishes. Its sleek, minimalist design features an impressive blade span.

### FEATURES

- Direct Drive™ motor / lifetime motor warranty
- 60" blade span
- Set of 3 exclusive reversible blades included
- Includes 7" downrod
- Minimum 9' ceiling required
- 172 x 18 motor
- Light kits sold separately

## TRIBECA 60"



### MOTOR & BLADE FINISHES



A



B



C

#### A: 59503

Snow White motor  
with Matte Snow White blades

#### B: 59504

Brushed Nickel motor with reversible  
Burnt Walnut / Walnut veneer blades

#### C: 59505

Graphite motor with reversible  
Walnut / Graphite veneer blades

### CONTROLS



#### Included

Universal Control  
Four-speed wall control with  
full-range light dimming,  
reversing and CFL mode.



#### 99020 (optional)

Universal Remote  
Four-speed remote control  
with full-range light dimming,  
reversing and CFL mode.

### DIMENSIONS AND ENERGY INFORMATION (AT HIGH SPEED)

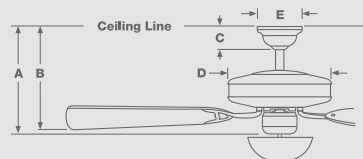

Dimensions	Airflow
A: 17.96"	6,709 cfm
B: 17.27"	Electricity Use
C: 2.75"	78-watt
D: 7.50"	Airflow Efficiency
E: 6.49"	86 cfm/watt
F: -	

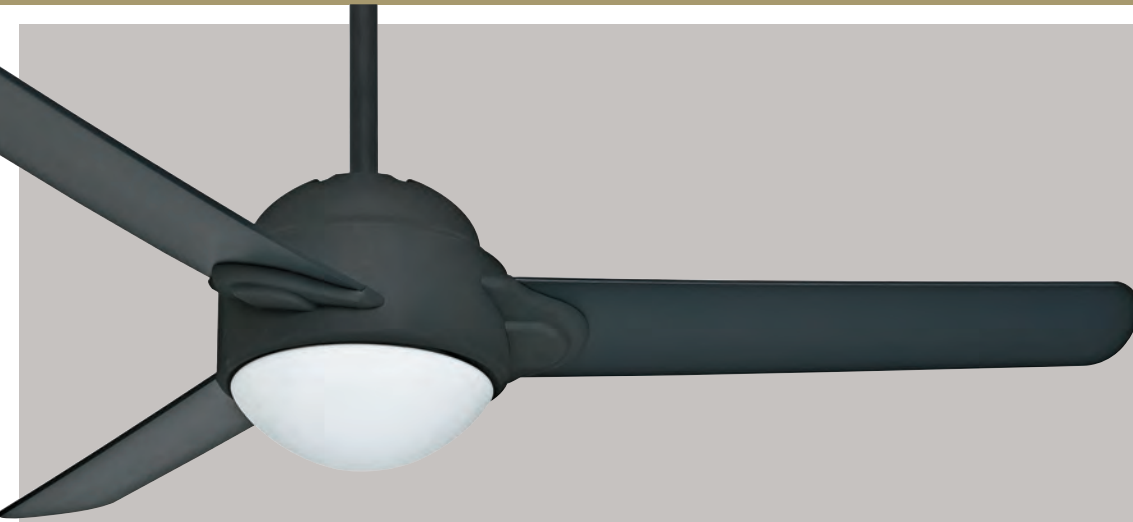

## 59081

Graphite motor with reversible Graphite/Walnut veneer blades and Cased White glass

Casablanca's Trident® ceiling fan epitomizes clean contemporary design and seamless performance. Its streamlined three-blade configuration, integrated halogen light, and matching no-light cap have been engineered to echo the agile grace of an airplane propeller.

### FEATURES

- Direct Drive™ motor / lifetime motor warranty
- 54" blade span
- Set of 3 exclusive reversible blades included
- Integrated 100-watt downlight with one T4 halogen bulb included
- Optional no-light cap included
- 172 x 20 motor

TRIDENT®   **BLADES**  
included

### MOTOR & BLADE FINISHES



A



B



C

#### A: 59081

Graphite motor with reversible Graphite / Walnut veneer blades and Cased White glass

#### B: 59082

Snow White motor with Snow White blades and Cased White glass

#### C: 59083

Brushed Nickel motor with reversible Espresso / Smoked Walnut veneer blades and Cased White glass

### CONTROLS



**Included**  
Universal Control  
Four-speed wall control with full-range light dimming, reversing and CFL mode.



**99020 (optional)**  
Universal Remote  
Four-speed remote control with full-range light dimming, reversing and CFL mode.

### DIMENSIONS AND ENERGY INFORMATION (AT HIGH SPEED)

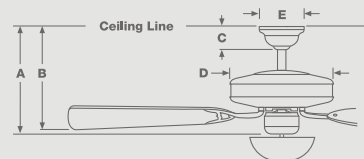

Dimensions	Airflow
A: —	7,010 cfm
B: 10.08"	Electricity Use
C: 2.75"	86-watt
D: 10.20"	Airflow Efficiency
E: 6.49"	82 cfm/watt
F: 14.15"	



## 59155

Satin Nickel motor with reversible Platinum / Black Mahogany blades

The sleek, triple-bladed Verse is all about the simple comfort expressed by its minimal design. With a strong emphasis on clean lines and subtle form, the Verse provides inspiration to any contemporary, transitional, or casual setting.

### FEATURES

- Direct Drive™ motor / lifetime motor warranty
- 44" blade span
- Set of 3 exclusive blades included
- Includes optional no-light cap
- Integrated 16-watt LED light kit
- ETL rated for damp or humid locations
- 172 x 12 motor



Includes low profile mounting kit (see page 99)



Includes optional no-light cap

VERSE 44"

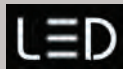

### MOTOR & BLADE FINISHES



A



B



C

#### A: 59153

Fresh White motor with Fresh White blades and Cased White glass

#### B: 59154

Maiden Bronze motor with reversible Maiden Bronze / Espresso blades and Cased White glass

#### C: 59155

Satin Nickel motor with reversible Platinum / Black Mahogany blades and Cased White glass

### CONTROLS



#### Included

Universal Remote  
Four-speed remote control with full-range light dimming.

### LIGHTING

Includes dimmable LED light kit.



#### Base:

Integrated LED

#### Wattage:

16 watts

#### LED Light Output:

1300 lumens

#### Correlated Color Temperature (CCT):

3000K

### DIMENSIONS AND ENERGY INFORMATION (AT HIGH SPEED)

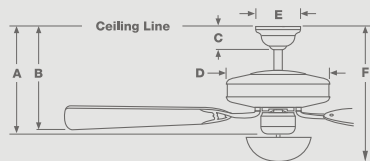

#### Dimensions

- A: —
- B: 10.15"
- C: 2.75"
- D: 11.79"
- E: 6.49"
- F: 14.06"

#### Airflow

4,159 cfm

#### Electricity Use

57-watt

#### Airflow Efficiency

73 cfm/watt





## 59158

Fresh White motor with Fresh White blades and Cased White Glass

The sleek, triple-bladed 54" Verse has the same minimal design as the smaller version but is intended for larger spaces. With a strong emphasis on clean lines and subtle form, the Verse provides inspiration to any contemporary, transitional, or casual setting.

### FEATURES

- Direct Drive™ motor / lifetime motor warranty
- 54" blade span
- Set of 3 exclusive blades included
- Includes optional no-light cap
- Integrated 16-watt LED light kit
- ETL rated for damp or humid locations
- 172 x 20 motor



Includes low profile mounting kit (see page 100)



Includes optional no-light cap

## VERSE 54"



### MOTOR & BLADE FINISHES



A



B



C

#### A: 59158

Fresh White motor with Fresh White blades and Cased White glass

#### B: 59159

Maiden Bronze motor with reversible Maiden Bronze / Espresso blades and Cased White glass

#### C: 59160

Satin Nickel motor with reversible Platinum / Black Mahogany blades and Cased White glass

### CONTROLS



**Included**  
Universal Remote  
Four-speed remote control with full-range light dimming.

### LIGHTING

Includes dimmable LED light kit.



#### Base:

Integrated LED

#### Wattage:

16 watts

#### LED Light Output:

1300 lumens

#### Correlated Color Temperature (CCT):

3000K

### DIMENSIONS AND ENERGY INFORMATION (AT HIGH SPEED)

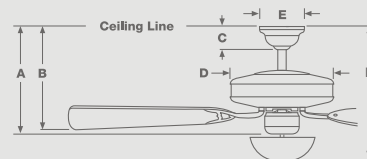

#### Dimensions

A:	-
B:	10.15"
C:	2.75"
D:	11.79"
E:	6.49"
F:	14.06"

#### Airflow

5,987 cfm

#### Electricity Use

78-watt

#### Airflow Efficiency

77 cfm/watt



## 59149

Fresh White motor with Pewter Blades and Cased White glass

A contemporary design with a little flare of retro, the Wisp brings a sense of finesse and a light airy aura that will inspire joy and comfort throughout the entire room.

### FEATURES

- Direct Drive™ motor / lifetime motor warranty
- 44" blade span
- Set of 3 blades included
- 4" and 2" downrods included
- Integrated LED light kit
- 172 x 12 motor

WISP 44"



### MOTOR & BLADE FINISHES



A



B

#### A: 59149

Fresh White motor with Pewter blades and Cased White glass

#### B: 59150

Pewter motor with Pewter blades and Cased White glass

### CONTROLS



#### Included

Universal Remote  
Four-speed remote control with full-range light dimming.

### LIGHTING

Includes dimmable LED light kit.

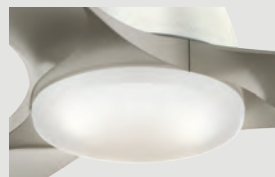

#### Base:

Integrated LED

#### Wattage:

18 watts

#### LED Light Output:

1400 lumens

#### Correlated Color Temperature (CCT):

3000K

### DIMENSIONS AND ENERGY INFORMATION (AT HIGH SPEED)

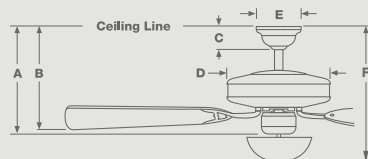

#### Dimensions†

A:	—
B:	12.08"
C:	2.75"
D:	8.65"
E:	6.49"
F:	13.96"

Airflow  
4,527 cfm

Electricity Use  
61-watt

Airflow Efficiency  
75 cfm/watt

†with 4" downrod (included)

FOR ALL THINGS  
DESIGN,  
FOLLOW US ON





## 59152

Pewter motor with Pewter Blades and Cased White glass

A contemporary design with a little flare of retro the Wisp brings a sense of finesse and a light airy aura that will inspire joy and comfort throughout the entire room.

### FEATURES

- Direct Drive™ motor / lifetime motor warranty
- 52" blade span
- Set of 3 blades included
- 4" and 2" downrods included
- Integrated LED light kit
- 172 x 20 motor

WISP 52"



### MOTOR & BLADE FINISHES



A



B

#### A: 59151

Fresh White motor with Pewter blades and Cased White glass

#### B: 59152

Pewter motor with Pewter blades and Cased White glass

### CONTROLS



#### Included

Universal Remote  
Four-speed remote control with full-range light dimming.

### LIGHTING

Includes dimmable LED light kit.



#### Base:

Integrated LED

#### Wattage:

18 watts

#### LED Light Output:

1400 lumens

#### Correlated Color Temperature (CCT):

3000K

### DIMENSIONS AND ENERGY INFORMATION (AT HIGH SPEED)

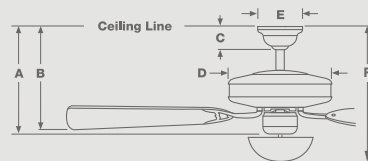

#### Dimensions\*

- A: —
- B: 12.08"
- C: 2.75"
- D: 8.65"
- E: 6.49"
- F: 13.96"

Airflow  
5,079 cfm

Electricity Use  
65-watt

Airflow Efficiency  
78 cfm/watt

\*with 4" downrod (included)



## 59111

Industrial Rust motor with reversible Mountain Timber/River Timber veneer blades and Cased White glass

From its memorable name to its edgy design, the Zudio is simply unique. Its contemporary design features blade arms that spin around the entire fan body for an exceptional look and feel.

### FEATURES

- Direct Drive™ motor / lifetime motor warranty
- 56" blade span
- Set of 5 exclusive blades included
- Integrated LED light kit
- 188 x 20 motor

ZUDIO



### MOTOR & BLADE FINISHES



A



B



C

#### A: 59109

Brushed Nickel motor with White Washed Distressed Oak veneer blades and Cased White glass

#### B: 59110

Snow White motor with Snow White blades and Cased White glass

#### C: 59111

Industrial Rust motor with reversible Mountain Timber/River Timber veneer blades and Cased White glass

### CONTROLS



#### Included

**Universal Control**  
Four-speed wall control with full-range light dimming, reversing and CFL mode.



#### 99020 (optional)

**Universal Remote**  
Four-speed remote control with full-range light dimming, reversing and CFL mode.

### LIGHTING

Includes dimmable LED light kit.



#### Base:

Integrated LED

#### Wattage:

16 watts

#### LED Light Output:

1300 lumens

#### Correlated Color Temperature (CCT):

3000K

### DIMENSIONS AND ENERGY INFORMATION (AT HIGH SPEED)

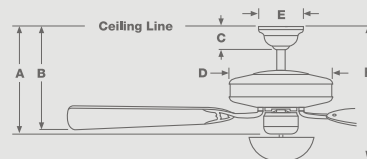

#### Dimensions

- A: —
- B: 11.96"
- C: 2.75"
- D: 9.73"
- E: 6.49"
- F: 13.20"

#### Airflow

6,468 cfm

#### Electricity Use

85-watt

#### Airflow Efficiency

76 cfm/watt



Ø 12.50  
[ 317,5 ]

6.14  
[ 156 ]

15.02  
[ 381,6 ]

CALEDONIA CEILING FAN



SECTION A-A

# LOW PROFILE

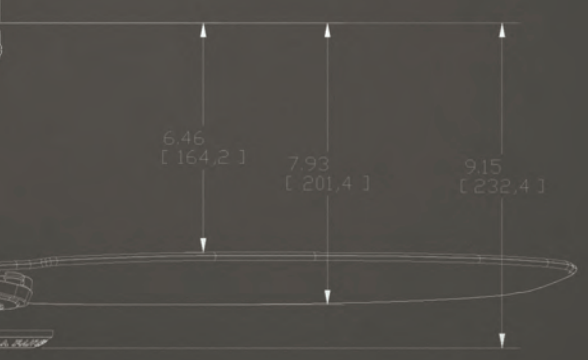



## 54105

Brushed Cocoa motor with reversible Distressed Walnut / Smoked Walnut veneer blades and Toffee glass

Inspired by the architecture of Ancient Greece, the 54" Caledonia is a beautiful combination of style and function. The ornamental detailing on the motor housing makes this a centerpiece in any home, while its powerful motor provides superior air circulation. Ideal for lower ceilings, the Caledonia is an intricate addition to any room.

### FEATURES

- Direct Drive™ motor / lifetime motor warranty
- 54" blade span
- Set of 5 blades included
- Includes three-light fitter with three 13-watt medium-based CFL bulbs
- 172 x 20 motor

## CALEDONIA



### MOTOR & BLADE FINISHES



A



B

#### A: 54105

Brushed Cocoa motor with reversible Distressed Walnut / Smoked Walnut veneer blades and Toffee glass

#### B: 54106

Burnished Creme motor with White Washed Distressed Oak veneer blades and Cased White glass

### CONTROLS



**Included**  
4-Speed Pullchain



**99019 (optional)**  
Universal Control System  
Four-speed remote control and receiver with full-range light dimming and CFL mode.

### DIMENSIONS AND ENERGY INFORMATION (AT HIGH SPEED)

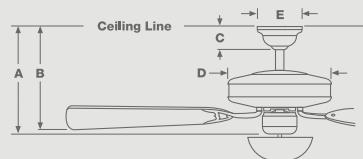

Dimensions	Airflow
A: 9.15"	4,388 cfm
B: 7.97"	Electricity Use
C: -	78-watt
D: 12.50"	Airflow Efficiency
E: -	56 cfm/watt
F: 15.02"	





## 53188

Maiden Bronze motor with reversible Smoked Walnut / Walnut veneer blades and Tea Stain glass

With simple styling that works almost anywhere, the Durant is a perfect fit for your home. It's a bit reminiscent of the futuristic Bel Geddes automobile designs of the 1930s. The repetition of form in the clean curved lines interplays with the extravagantly rounded features to create the perfect archetype for traditional low-profile fans.

### FEATURES

- Direct Drive™ motor / lifetime motor warranty
- 44" blade span
- Set of 5 blades included
- Includes three-light fitter with three 13-watt medium based CFL bulbs
- 172 x 12 motor

## DURANT 44"



### MOTOR & BLADE FINISHES



A



B

#### A: 53187

Brushed Nickel motor with reversible Walnut / Burnt Walnut veneer blades and Cased White glass

#### B: 53188

Maiden Bronze motor with reversible Smoked Walnut / Walnut veneer blades and Tea Stain glass

### CONTROLS



**Included**  
4-Speed Pullchain



**99019 (optional)**  
Universal Control System  
Four-speed remote control and receiver with full-range light dimming and CFL mode.

### DIMENSIONS AND ENERGY INFORMATION (AT HIGH SPEED)

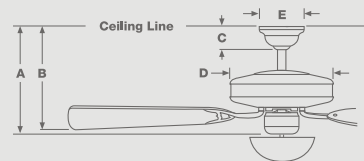

Dimensions	Airflow
A: 8.90"	3,375 cfm
B: 7.75"	Electricity Use
C: -	61-watt
D: 12.50"	Airflow Efficiency
E: -	55 cfm/watt
F: 14.80"	



## 54101

Brushed Nickel motor with reversible Walnut / Burnt Walnut veneer blades and Cased White glass

With simple styling that works almost anywhere, the Durant is a perfect fit for your home. It's a bit reminiscent of the futuristic Bel Geddes automobile designs of the 1930s. The repetition of form in the clean curved lines interplays with the extravagantly rounded features to create the perfect archetype for traditional low-profile fans.

### FEATURES

- Direct Drive™ motor / lifetime motor warranty
- 54" blade span
- Set of 5 blades included
- Includes bowl light fixture with two 13-watt medium-based CFL bulbs
- 4-speed pullchain
- 172 x 20 motor

## DURANT 54"



BLADES  
included

### MOTOR & BLADE FINISHES



A



B

#### A: 54101

Brushed Nickel motor with reversible Walnut / Burnt Walnut veneer blades and Cased White glass

#### B: 54102

Maiden Bronze motor with reversible Smoked Walnut / Walnut veneer blades and Tea Stain glass

### CONTROLS



**Included**  
4-Speed Pullchain



**99019 (optional)**  
Universal Control System  
Four-speed remote control and receiver with full-range light dimming and CFL mode.

### DIMENSIONS AND ENERGY INFORMATION (AT HIGH SPEED)

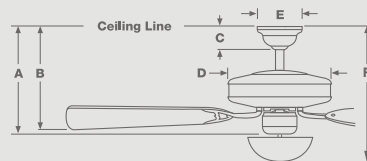

Dimensions

A: 8.90"  
B: 7.81"  
C: -  
D: 12.50"  
E: -  
F: 14.11"

Airflow  
4,249 cfm

Electricity Use  
81-watt

Airflow Efficiency  
53 cfm/watt



## 54103

Snow White motor with Snow White blades

With simple styling that works almost anywhere, the Durant is a perfect fit for your home. It's a bit reminiscent of the futuristic Bel Geddes automobile designs of the 1930s. The repetition of form in the clean curved lines interplays with the extravagantly rounded features to create the perfect archetype for traditional low-profile fans.

### FEATURES

- Direct Drive™ motor / lifetime motor warranty
- 54" blade span
- Set of 5 blades included
- 172 x 20 motor
- Light kits sold separately

## DURANT 54"



### MOTOR & BLADE FINISHES



A

**A: 54103**

Snow White motor with Snow White blades

### CONTROL

**Included**

4-Speed Pullchain



**99019 (optional)**

Universal Control System

Four-speed remote control and receiver with full-range light dimming and CFL mode.

### LIGHTING

Our design team's recommended lighting option.



**99023**

Glass Bowl Fitter

**99059**

Cased White Glass Bowl

For all other compatible light fixtures, see pages 127-130.

### DIMENSIONS AND ENERGY INFORMATION (AT HIGH SPEED)

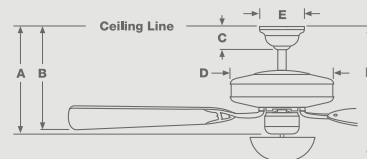

#### Dimensions

A:	8.90"
B:	7.81"
C:	—
D:	12.50"
E:	—
F:	—

#### Airflow

4,412 cfm

Electricity Use

82-watt

Airflow Efficiency

54 cfm/watt



## 59019

Brushed Nickel motor with Espresso blades and Cased White glass

The smaller bladed version of the Isotope® takes this sleek, contemporary styling and superior functionality to almost any room in your home. A superior option for flush-mount installation with lower ceilings.

### FEATURES

- Direct Drive™ motor / lifetime motor warranty
- 44" blade span
- Set of 5 exclusive blades included
- Integrated 100-watt downlight with two 50-watt T4 halogen bulbs included
- 188 x 20 motor

ISOTOPE® 44"   **BLADES** included

### MOTOR & BLADE FINISHES



A



B



C

#### A: 59018

Snow White motor with Snow White blades and Cased White glass

#### B: 59019

Brushed Nickel motor with Espresso blades and Cased White glass

#### C: 59020

Brushed Cocoa motor with Espresso blades and Cased White glass

### CONTROLS



#### Included

Universal Control  
Four-speed wall control with full-range light dimming, reversing and CFL mode.



#### 99020 (optional)

Universal Remote  
Four-speed remote control with full-range light dimming, reversing and CFL mode.

### DIMENSIONS AND ENERGY INFORMATION (AT HIGH SPEED)

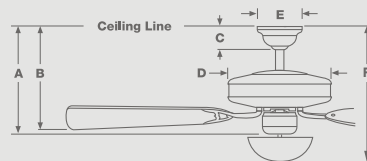

#### Dimensions

A:	-
B:	9.59"
C:	-
D:	10.20"
E:	-
F:	12.76"

Airflow  
**4,032 cfm**

Electricity Use  
**88-watt**

Airflow Efficiency  
**46 cfm/watt**



## 59023

Brushed Cocoa motor with Espresso blades and Cased White glass

Superior air circulation meets sleek, contemporary design. With a low profile and swept-wing blade configuration, the Isotope® is ideal for flush-mount installation in interiors with lower ceilings.

### FEATURES

- Direct Drive™ motor / lifetime motor warranty
- 52" blade span
- Set of 5 exclusive blades included
- Integrated 100-watt downlight with two 50-watt T4 halogen bulbs included
- 188 x 20 motor

## ISOTOPE® 52"



### MOTOR & BLADE FINISHES



A



B



C

#### A: 59021

Snow White motor with Snow White blades and Cased White glass

#### B: 59022

Brushed Nickel motor with Espresso blades and Cased White glass

#### C: 59023

Brushed Cocoa motor with Espresso blades and Cased White glass

### CONTROLS



#### Included

**Universal Control**  
Four-speed wall control with full-range light dimming, reversing and CFL mode.



#### 99020 (optional)

**Universal Remote**  
Four-speed remote control with full-range light dimming, reversing and CFL mode.

### DIMENSIONS AND ENERGY INFORMATION (AT HIGH SPEED)

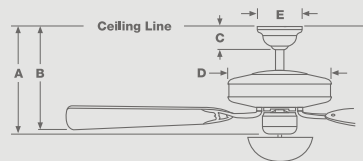

Dimensions	Airflow
A: —	<b>3,849</b> cfm
B: 9.59"	Electricity Use
C: —	<b>69</b> -watt
D: 10.20"	Airflow Efficiency
E: —	<b>56</b> cfm/watt
F: 12.76"	



## 59155

Satin Nickel motor with reversible Platinum / Black Mahogany blades and Cased White glass

The sleek, triple-bladed Verse is all about the simple comfort expressed by its minimal design. With a strong emphasis on clean lines and subtle form, the Verse provides inspiration to any contemporary, transitional, or casual setting.

### FEATURES

- Direct Drive™ motor / lifetime motor warranty
- 44" blade span
- Set of 3 exclusive blades included
- Includes optional no-light cap
- Integrated 16-watt LED light kit
- ETL rated for damp or humid locations
- 172 x 12 motor



Includes standard mounting option (see page 85)



Includes optional no-light cap

VERSE 44"



### MOTOR & BLADE FINISHES



A



B



C

#### A: 59153

Fresh White motor with Fresh White blades and Cased White glass

#### B: 59154

Maiden Bronze motor with reversible Maiden Bronze / Espresso blades and Cased White glass

#### C: 59155

Satin Nickel motor with reversible Platinum / Black Mahogany blades and Cased White glass

### CONTROLS



#### Included

Universal Remote  
Four-speed remote control with full-range light dimming.

### LIGHTING

Includes dimmable LED light kit.



#### Base:

Integrated LED

#### Wattage:

16 watts

#### LED Light Output:

1300 lumens

#### Correlated Color Temperature (CCT):

3000K

### DIMENSIONS AND ENERGY INFORMATION (AT HIGH SPEED)

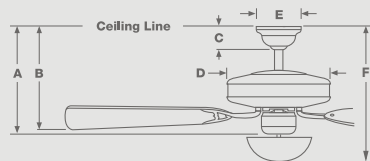

#### Dimensions

- A: —
- B: 10.15"
- C: 2.75"
- D: 11.79"
- E: 6.49"
- F: 14.06"

Airflow  
4,159 cfm

Electricity Use  
57-watt

Airflow Efficiency  
73 cfm/watt



## 59158

Fresh White motor with Fresh White blades and Cased White glass

The sleek, triple-bladed 54" Verse has the same minimal design as the smaller version but is intended for larger spaces. With a strong emphasis on clean lines and subtle form, the Verse provides inspiration to any contemporary, transitional, or casual setting.

### FEATURES

- Direct Drive™ motor / lifetime motor warranty
- 54" blade span
- Set of 3 exclusive blades included
- Includes optional no-light cap
- Integrated 16-watt LED light kit
- ETL rated for damp or humid locations
- 172 x 20 motor



Includes standard mounting option (see page 86)



Includes optional no-light cap

# VERSE 54"



### MOTOR & BLADE FINISHES



A



B



C

#### A: 59158

Fresh White motor with Fresh White blades and Cased White glass

#### B: 59159

Maiden Bronze motor with reversible Maiden Bronze / Espresso blades and Cased White glass

#### C: 59160

Satin Nickel motor with reversible Platinum / Black Mahogany blades and Cased White glass

### CONTROLS



**Included**  
Universal Remote  
Four-speed remote control with full-range light dimming.

### LIGHTING

Includes dimmable LED light kit.



#### Base:

Integrated LED

#### Wattage:

16 watts

#### LED Light Output:

1300 lumens

#### Correlated Color Temperature (CCT):

3000K

### DIMENSIONS AND ENERGY INFORMATION (AT HIGH SPEED)

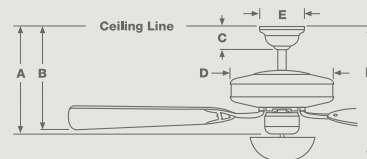

#### Dimensions

- A: —
- B: 10.15"
- C: 2.75"
- D: 11.79"
- E: 6.49"
- F: 14.06"

#### Airflow

5,987 cfm

#### Electricity Use

78-watt

#### Airflow Efficiency

77 cfm/watt

CAPTER, MOTOR TO DOWNROD  
 #8-32 THMS, W/ SEMS  
 M3-0.5 PHMS, W/ SEMS  
 #6-32 RHMS, W/ SEMS  
 1/4-20 SOHSS, CUP POINT  
 -20 PHHCS, W/ SPLIT LOCK  
 ASSEMBLY, TRILOBE DOWNROD  
 WASHER, #10 METAL  
 REVERSE SWITCH, 2 POSITION  
 CAUTION TAG, SET SCREW  
 LABEL, DAMP LOCATIONS  
 A NPL, ETL PARTIAL PLATFORM  
 CONTROL  
 HOUSING  
 WELDMENT, BOTTOM HOUSING  
 SUB-ASSY, BELLY BAND  
 BLADE IRON, 16 DEG SPCL  
 CAP,  
 BLADE SET, 25" METAL  
 BLADE IRON, SUB ASSY  
 CAP MOUNT, SUB ASSY  
 A MODERN, CANOPY ASSEMBLY  
 THRU BOLT, #10-32 RHMS  
 OWNER'S MANUAL, ---

FINISH CODE:R 20  
 FINISH CODE:H 15  
 FINISH CODE:H 12  
 FINISH CODE:R 2  
 FINISH CODE:R 3  
 FINISH CODE:B 14  
 FINISH CODE:H 25  
 FINISH CODE:H 18  
 FINISH CODE:F2 33

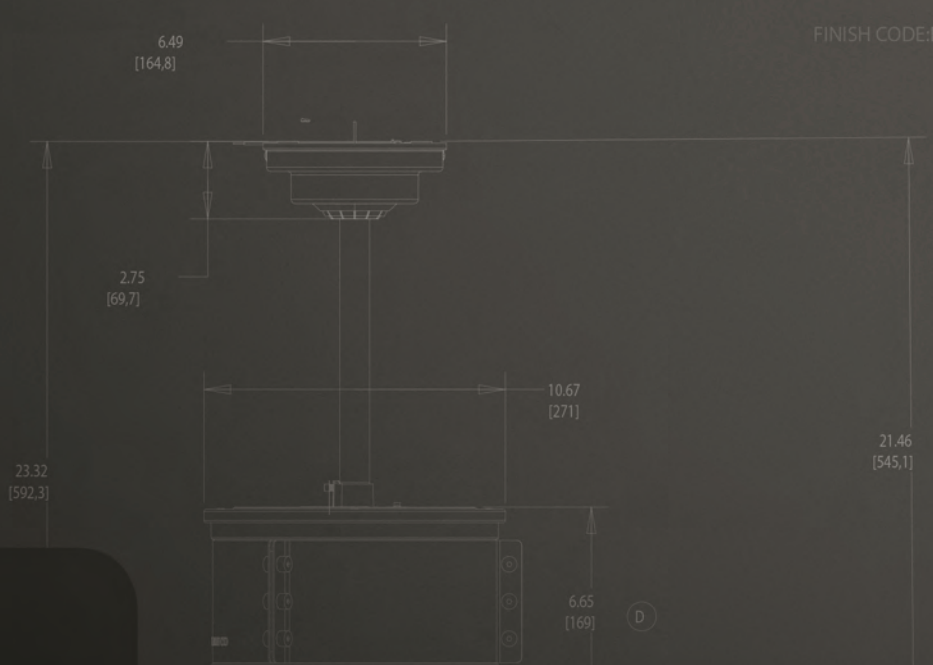
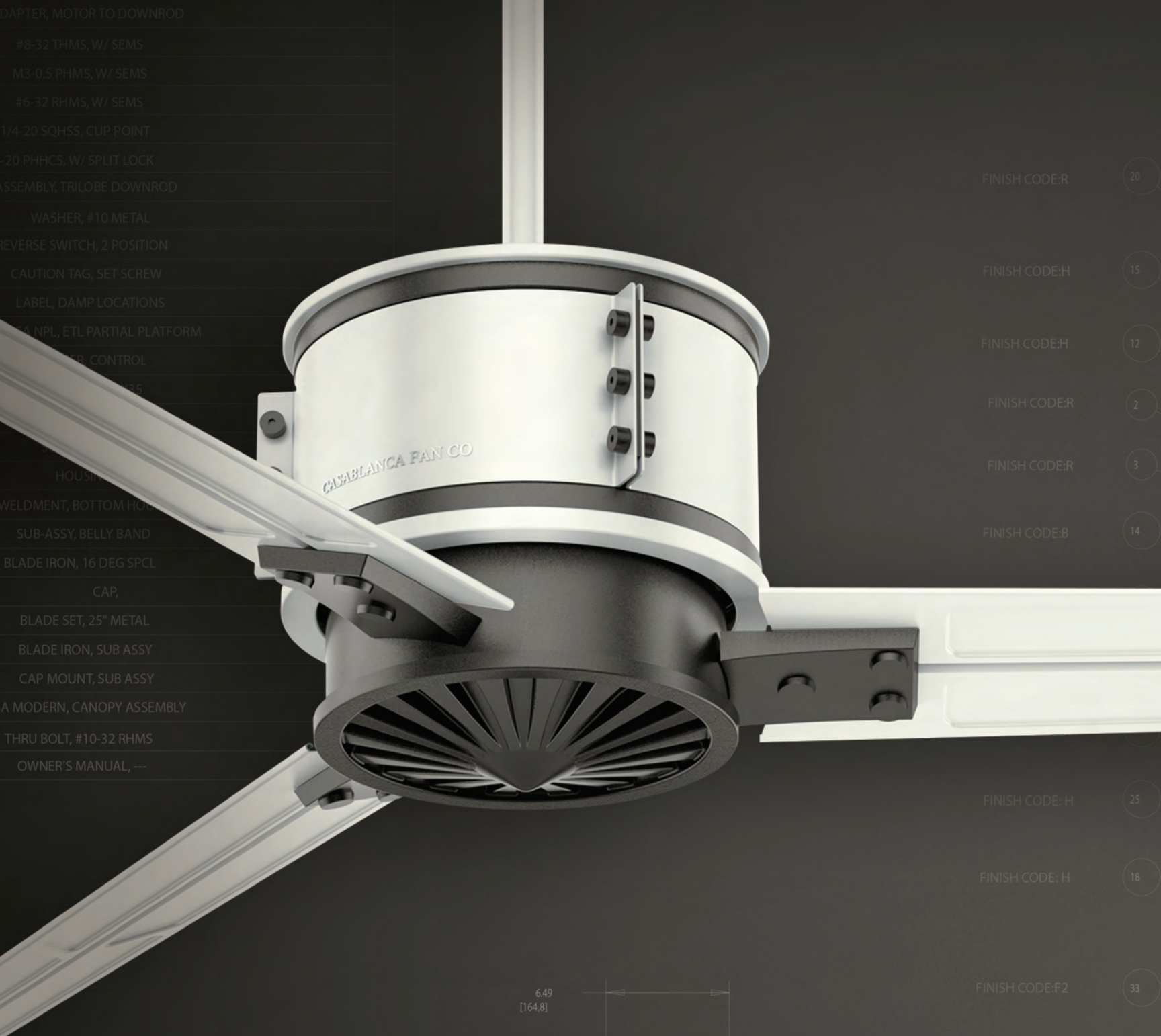

DULUTH 72" CEILING FAN





SECTION A-A  
SCALE 0.500

16 FINISH CODE: H

31 FINISH CODE: F2

# OUTDOOR

1 FINISH CODE: R

21 FINISH CODE: R

13 FINISH CODE: H

5 FINISH CODE: R

F	ADD
E	ADD
D	NOVA
C	CH
B	NOVA
A	INT
REV	



## 59124

Brushed Cocoa motor with  
Burnished Mahogany All-Weather blades

Clean and simple design that appeals to the senses. Wood-tone finishes dipped in film put the exclamation point on this contemporary model.

### FEATURES

- Direct Drive™ motor / lifetime motor warranty
- 54" blade span
- Set of 4 exclusive blades included
- 172 x 20 motor
- Light kits sold separately
- ETL rated for damp or humid locations

ARIS



### MOTOR & BLADE FINISHES

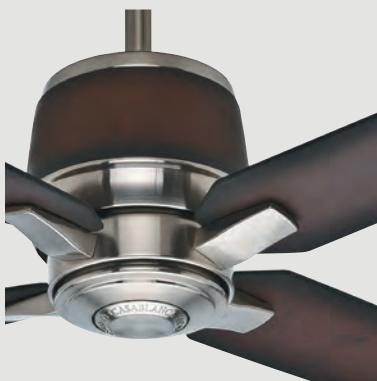

A

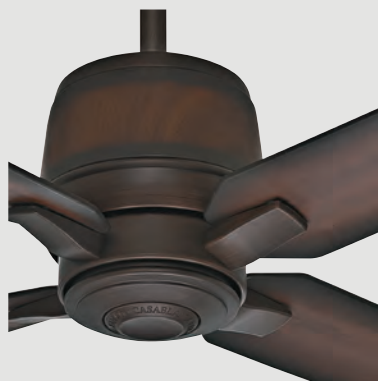

B

#### A: 59123

Brushed Nickel motor with  
Mayse All-Weather blades

#### B: 59124

Brushed Cocoa motor with  
Burnished Mahogany  
All-Weather blades

### CONTROLS



#### Included

Universal Control  
Four-speed wall control with  
full-range light dimming,  
reversing and CFL mode.



#### 99020 (optional)

Universal Remote  
Four-speed remote control  
with full-range light dimming,  
reversing and CFL mode.

### DIMENSIONS AND ENERGY INFORMATION (AT HIGH SPEED)

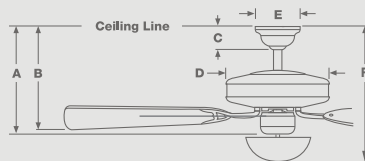

Dimensions	Airflow
A: 14.69"	6,196 cfm
B: 12.78"	Electricity Use
C: 2.75"	82-watt
D: 8.74"	Airflow Efficiency
E: 6.49"	75 cfm/watt
F: -	



## 64395 (C18G500F)

Aged Bronze motor with outdoor carved featherwood blades in Reclaimed Antique

Make a statement of graceful refinement on a grand scale with the damp-rated Atria® ceiling fan. The faux alabaster motor housing includes an uplight and a downlight that illuminates the entire fan body with a warm, ambient glow.

### FEATURES

- XTR200™ 30mm motor / lifetime motor warranty
- ETL rated for damp or humid locations
- 68" blade span
- Set of 5 exclusive outdoor carved featherwood blades included
- Integrated 120-watt uplight with eight 15-watt bulbs included
- Integrated 100-watt downlight with two 50-watt T4 halogen bulbs included
- Requires additional hanging support (included)
- 200 x 30 motor
- Minimum 9' ceiling required

*Discontinued - while supplies last*

ATRIA®



### MOTOR & BLADE FINISHES



A

#### A: 64395 (C18G500F)

Aged Bronze motor with outdoor carved featherwood blades in Reclaimed Antique

### CONTROLS



#### Included

W-81

Four-speed wall control with full-range light dimming. No reversing function.

### DIMENSIONS AND ENERGY INFORMATION (AT HIGH SPEED)

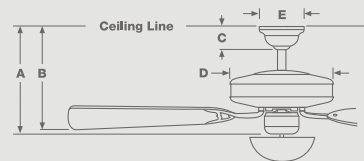

Dimensions	Airflow
A: 28.80"	9,042 cfm
B: 23.40"	Electricity Use
C: 3.00"	93-watt
D: 17.10"	Airflow Efficiency
E: 5.60"	97 cfm/watt
F: -	



## 59114

Maiden Bronze motor with Smoked Walnut All-Weather blades and Cased White glass

Damp-rated with an imaginative style, this outdoor model features a unique, integrated halogen light that is sure to be the focus of any room. By combining a nautical theme with an industrial edge, the Caneel Bay has a look that is entirely its own.

### FEATURES

- Direct Drive™ motor / lifetime motor warranty
- 56" blade span
- Set of 5 blades included
- Includes 6" downrod
- 188 x 20 motor
- Integrated light kit with two 50-watt halogen bulbs included
- ETL rated for damp or humid locations

## CANEEL BAY



### MOTOR & BLADE FINISHES



A



B

#### A: 59113

Aged Steel motor with White Washed Distressed Oak All-Weather blades and Cased White glass

#### B: 59114

Maiden Bronze motor with Smoked Walnut All-Weather blades and Cased White glass

### CONTROLS



#### Included

Universal Control  
Four-speed wall control with full-range light dimming, reversing and CFL mode.



#### 99020 (optional)

Universal Remote  
Four-speed remote control with full-range light dimming, reversing and CFL mode.

### DIMENSIONS AND ENERGY INFORMATION (AT HIGH SPEED)

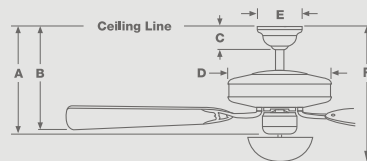

#### Dimensions

- A: —
- B: 13.04"
- C: 2.75"
- D: 10.03"
- E: 6.49"
- F: 16.79"

Airflow  
6,585 cfm

Electricity Use  
87-watt

Airflow Efficiency  
75 cfm/watt



## 54028

Snow White motor shown with 99021 Matte Snow White All-Weather blades (sold separately)

Subtle sophistication is a dominant theme in today's décor. With a soft, sculpted look and the nautical suggestion of seashells, no other fan compliments this attitude like the damp-rated Capistrano®.

### FEATURES

- Direct Drive™ motor / lifetime motor warranty
- 54"-60" blade span
- Multiple blade finish choices available (blades sold separately)
- Select models ETL rated for damp or humid locations
- 172 x 20 motor
- Light kits sold separately

CAPISTRANO®



### MOTOR FINISHES



A



B

#### A: 54028

Snow White motor shown with 99021 Matte Snow White All-Weather blades

#### B: 54030

Brushed Cocoa motor shown with 99022 Cocoa All-Weather blades

### BLADES

Customize your fan with blades that reflect your style. Choose from a variety of finishes and shapes. See foldout on page 15.



### LIGHTING

Our design team's recommended lighting option.

#### 99088

Outdoor Four-light Fixture in Snow White



For all other compatible light fixtures, see pages 127-130.

### CONTROLS



**Included**  
4-Speed Pullchain



**99019 (optional)**  
Universal Control System  
Four-speed remote control and receiver with full-range light dimming and CFL mode.

### DIMENSIONS AND ENERGY INFORMATION (AT HIGH SPEED)

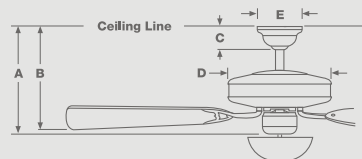

Dimensions	Airflow
A: 13.12"	6,863 cfm
B: 11.67"	Electricity Use
C: 2.75"	81-watt
D: 12.50"	Airflow Efficiency
E: 6.50"	85 cfm/watt
F: -	

\*Energy information based on 99004 blade set.

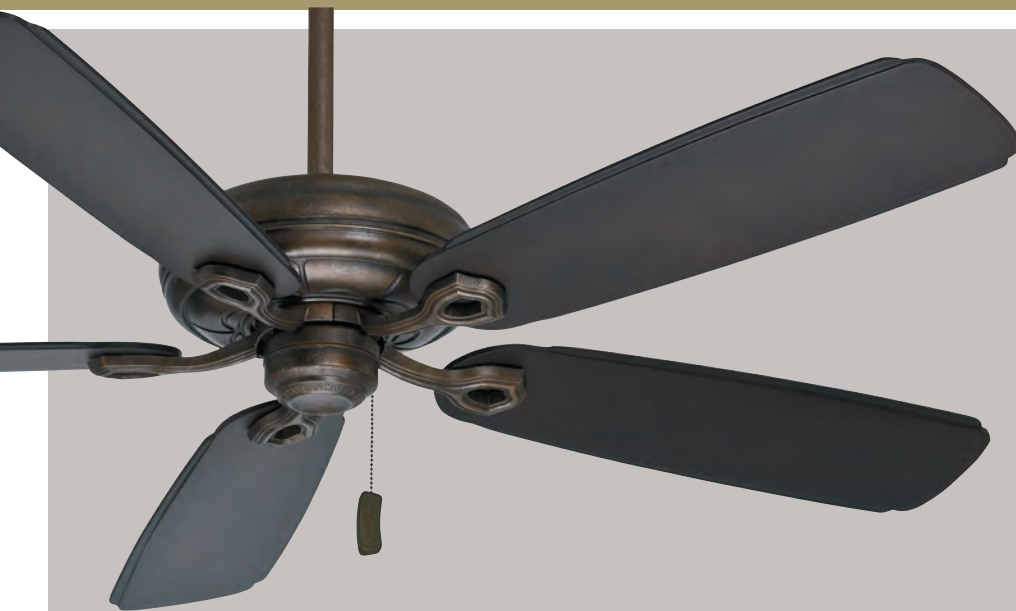

## 55011

Aged Bronze motor shown with 99018 Espresso All-Weather blades (sold separately)

Transport yourself to a secluded beach house from any room in your home. With its delightfully simple styling, the Charthouse® creates a relaxed, airy feel that will truly take you away. Choose the perfect blade and finish combination to match your style.

### FEATURES

- Direct Drive™ motor / lifetime motor warranty
- 54"-60" blade span
- Multiple blade finish choices available (blades sold separately)
- ETL rated for wet locations
- 188 x 20 motor
- Light kits sold separately

CHARTHOUSE®



### MOTOR FINISHES

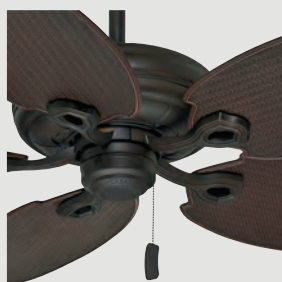

A

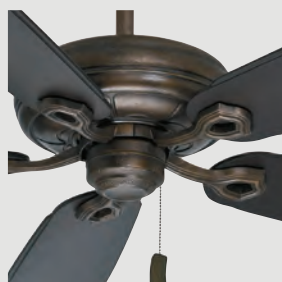

B

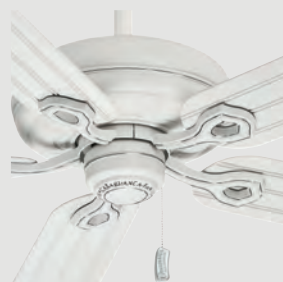

C

#### A: 55010

Maiden Bronze motor shown with 99016 Plantation Wicker All-Weather blades

#### B: 55011

Aged Bronze motor shown with 99018 Espresso All-Weather blades

#### C: 55012

Cottage White motor shown with 99014 Cottage White Beadboard All-Weather blades

### BLADES

Customize your fan with blades that reflect your style. Choose from a variety of finishes and shapes. See foldout on page 15.



### LIGHTING

Our design team's recommended lighting option.



#### 99079

Outdoor Low Profile Fitter in Aged Bronze

#### 99084

Low Profile Glass in Toffee

For all other compatible light fixtures, see pages 127-130.

### CONTROLS



#### Included

4-Speed Pullchain



#### 99019 (optional)

Universal Control System  
Four-speed remote control and receiver with full-range light dimming and CFL mode.

### DIMENSIONS AND ENERGY INFORMATION (AT HIGH SPEED)

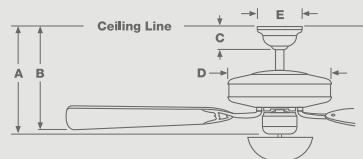

Dimensions	Airflow
A: 13.13"	7,206 cfm
B: 11.92"	Electricity Use
C: 2.75"	86-watt
D: 12.50"	Airflow Efficiency
E: 6.49"	83 cfm/watt
F: -	

\*Energy information based on 99004 blade set.



## 54010

Cottage White motor shown with 99017 Cottage White All-Weather blades (sold separately)

Being one of our most distinctive designs, the Compass Point® shows how something so simple can add so much to a room. It is built to last outside which makes it a fine choice for covered porches and sunrooms. The fan is available in two finishes with a wide range of accessory blade options.

### FEATURES

- Direct Drive™ motor / lifetime motor warranty
- 54"-60" blade span
- Multiple blade finish choices available (blades sold separately)
- ETL rated for damp or humid locations
- 172 x 20 motor
- Light kits sold separately

COMPASS POINT®



### MOTOR FINISHES



A



B

#### A: 54010

Cottage White motor shown with 99017 Cottage White All-Weather blades

#### B: 54011

Maiden Bronze motor shown with 99015 Distressed Antique Halifax All-Weather blades

### BLADES

Customize your fan with blades that reflect your style. Choose from a variety of finishes and shapes. See foldout on page 15.



### LIGHTING

Our design team's recommended lighting option.

#### 99089

Outdoor Four-Light Fixture in Cottage White



For all other compatible light fixtures, see pages 127-130.

### CONTROLS



**Included**  
4-Speed Pullchain



**99019 (optional)**  
Universal Control System  
Four-speed remote control and receiver with full-range light dimming and CFL mode.

### DIMENSIONS AND ENERGY INFORMATION (AT HIGH SPEED)\*

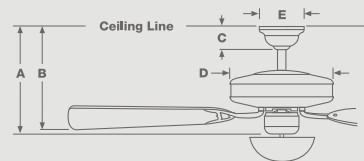

Dimensions	Airflow
A: 13.11"	6,590 cfm
B: 11.58"	Electricity Use
C: 2.75"	83-watt
D: 9.17"	Airflow Efficiency
E: 6.49"	80 cfm/watt
F: -	

\*Energy information based on 99004 blade set.



## 55065

Snow White motor shown with 990012  
Matte White All-Weather blades  
(sold separately)

The Crestmont has a strong presence that fits with a variety of styles. Featuring our new wide switch housing for a more modern look, this fan offers traditional composition with a contemporary twist. The design is influenced by Naval architecture, particularly the multi-dimensional appearance of transverse frames found in boat hulls. The interplay between flowing curves and rigid lines throughout the fan body uses these same ideas to create a unique, classic feel.

### FEATURES

- Direct Drive™ motor / lifetime motor warranty
- 54"-60" blade span
- Multiple blade finish choices available (blades sold separately)
- Light kits sold separately
- ETL rated for damp or humid locations
- 188 x 20 motor

# CRESTMONT



### MOTOR FINISHES



A



B



C

#### A: 55063

Brushed Nickel motor shown with 99013  
Black Mahogany All-Weather blades

#### B: 55064

Brushed Cocoa motor shown with 99018  
Espresso All-Weather blades

#### C: 55065

Snow White motor shown with 99012  
Matte Snow White All-Weather blades

### BLADES

Customize your fan with blades that reflect your style. Choose from a variety of finishes and shapes. See foldout on page 15.



### LIGHTING

Our design team's recommended lighting option.



#### 99088

Outdoor Four-light Fixture  
in Snow White

For all other compatible light fixtures, see pages 127-130.

### CONTROLS



#### Included

Universal Control  
Four-speed wall control with full-range light dimming, reversing and CFL mode.



#### 99020 (optional)

Universal Remote  
Four-speed remote control with full-range light dimming, reversing and CFL mode.

### DIMENSIONS AND ENERGY INFORMATION (AT HIGH SPEED)

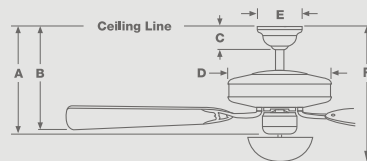

Dimensions	Airflow
A: 12.50"	6,519 cfm
B: 11.77"	Electricity Use
C: 2.75"	86-watt
D: 13.08"	Airflow Efficiency
E: 6.49"	76 cfm/watt
F: -	

\*Energy information based on 99004 blade set.





## 59192

Fresh White / Granite motor with Fresh White blades

Boasting purely industrial aesthetics from top to bottom, this fan carries a certain grace and ease that allows it to blend right in to any loft or contemporary environment.

### FEATURES

- Direct Drive™ motor / lifetime motor warranty
- 60" blade span
- Set of 3 blades included
- 11" downrod included
- Minimum 9' ceiling required
- Select models ETL rated for damp or humid locations
- 212 x 35 motor

## DULUTH 60"



BLADES  
included

DAMP  
RATED

NEW

FRESH WHITE ONLY

### MOTOR & BLADE FINISHES



A

#### A: 59192

Fresh White / Granite motor with Fresh White blades

### Tip

Galvanized Steel finish available for indoor use only (see page 67)

### CONTROLS



**Included**  
Stepped Wall Control  
Three-speed wall control operates forward and reverse.

### DIMENSIONS AND ENERGY INFORMATION (AT HIGH SPEED)

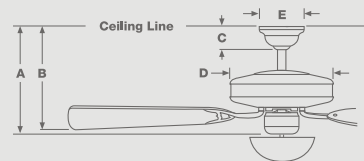

Dimensions*	Airflow	Electricity Use	Airflow Efficiency
A: 22.32"	7,988 cfm		
B: 21.46"		113-watt	
C: 2.75"			
D: 10.67"			
E: 6.49"			71 cfm/watt
F: -			

\*with 11" downrod (included)



## 59194

Fresh White / Granite motor with  
Fresh White blades

Boasting purely industrial aesthetics from top to bottom, this fan carries a certain grace and ease that allows it to blend right in to any loft or contemporary environment.

### FEATURES

- Direct Drive™ motor / lifetime motor warranty
- 72" blade span
- Set of 3 blades included
- 11" downrod included
- Minimum 9' ceiling required
- Select models ETL rated for damp or humid locations
- 212 x 35 motor

# DULUTH 72"



FRESH WHITE ONLY

### MOTOR & BLADE FINISHES



A

### A: 59194

Fresh White / Granite motor with  
Fresh White blades

### Tip

Galvanized Steel finish  
available for  
indoor use only  
(see page 68)

### CONTROLS



#### Included

Stepped Wall Control  
Three-speed wall control  
operates forward and reverse.

### DIMENSIONS AND ENERGY INFORMATION (AT HIGH SPEED)

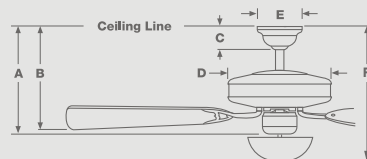

Dimensions*	Airflow
A: 22.32"	9,475 cfm
B: 21.46"	Electricity Use
C: 2.75"	110-watt
D: 10.67"	Airflow Efficiency
E: 6.49"	86 cfm/watt
F: -	

\*with 11" downrod (included)

FOR ALL THINGS  
DESIGN,  
FOLLOW US ON

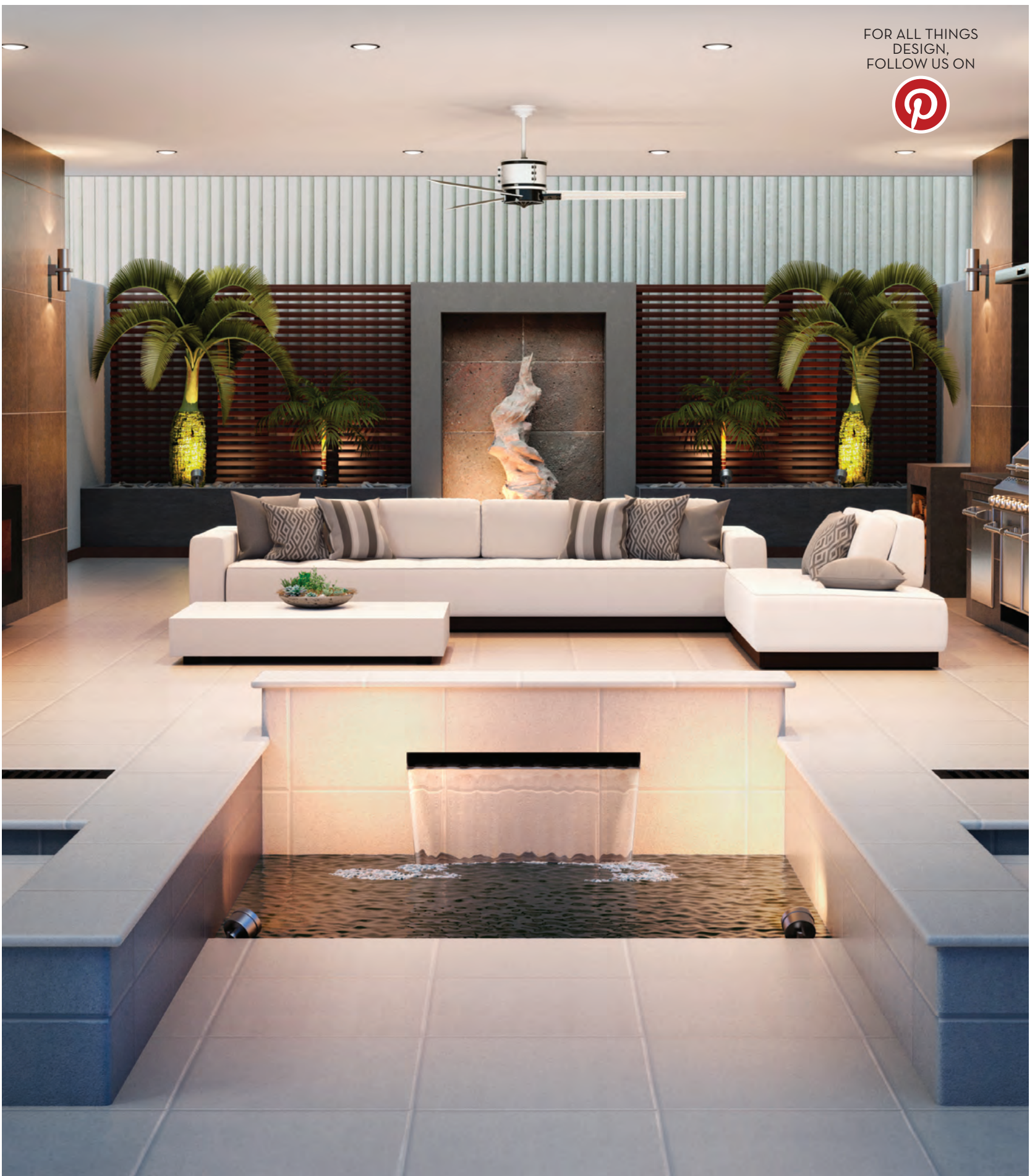



## 55051

Aged Steel motor with outdoor carved featherwood blades in Mountain Timber

Inspired by the latest high-end furniture trends, the Heathridge's body has the appearance of turned wood that complements its solid wood blades. Simple, sophisticated and perfect for updating any room.

### FEATURES

- Direct Drive™ motor / lifetime motor warranty
- 60" blade span
- Set of 5 solid featherwood blades
- 188 x 20 motor
- Includes four-light fitter with four 40-watt candelabra incandescent bulbs
- ETL rated for damp or humid locations

# HEATHRIDGE



### MOTOR & BLADE FINISHES



A



B

#### A: 55051

Aged Steel motor with outdoor carved featherwood blades in Mountain Timber and Sepia glass

#### B: 55052

Tahoe motor with outdoor carved featherwood blades in River Timber and Sepia glass

### CONTROLS



#### Included

Universal Control  
Four-speed wall control with full-range light dimming, reversing and CFL mode.



#### 99020 (optional)

Universal Remote  
Four-speed remote control with full-range light dimming, reversing and CFL mode.

### DIMENSIONS AND ENERGY INFORMATION (AT HIGH SPEED)

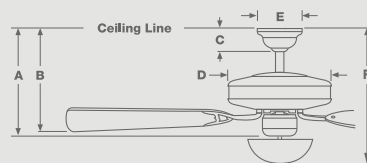

#### Dimensions

A:	13.12"
B:	11.76"
C:	2.75"
D:	15.21"
E:	6.49"
F:	20.32"

#### Airflow

6,191 cfm

#### Electricity Use

87-watt

#### Airflow Efficiency

70 cfm/watt



## 59527

Aged Bronze motor with outdoor carved featherwood blades in Reclaimed Antique

During the Industrial Revolution, innovations in manufacturing enabled artisans to create furniture from cast iron. The Heritage™ incorporates many of the design details featured in antique castings from this era. The fan features vertical ribbing on its motor housing, raised type on the switch cap, and a custom cobblestone texture on the fan body, cap, and inset portions of the blade medallions.

### FEATURES

- Direct Drive™ / lifetime motor warranty
- 60" blade span
- Set of 5 exclusive outdoor blades
- Moisture-resistant motor and enclosed housing
- Stainless steel hardware
- Minimum 8' ceiling required
- 188 x 20 motor
- Light kits sold separately
- ETL rated for wet locations

HERITAGE™



### MOTOR & BLADE FINISHES



A



B

#### A: 59527

Aged Bronze motor with outdoor carved featherwood blades in Reclaimed Antique

#### B: 59528

Brushed Cocoa motor with outdoor carved featherwood blades in Reclaimed Antique

### CONTROLS



**Included**  
4-Speed Pullchain



**99019 (optional)**  
Universal Control System  
Four-speed remote control and receiver with full-range light dimming and CFL mode.

### LIGHTING

Our design team's recommended lighting option.



**99087**  
Outdoor Four-Light Fixture in Aged Bronze

For all other compatible light fixtures, see pages 127-130.

### DIMENSIONS AND ENERGY INFORMATION (AT HIGH SPEED)

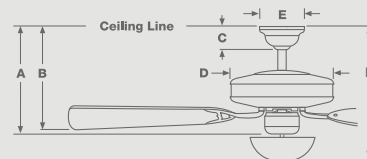

Dimensions	
A:	13.02"
B:	11.97"
C:	2.75"
D:	15.96"
E:	6.49"
F:	-

Airflow	
	6,865 cfm
Electricity Use	
	82-watt
Airflow Efficiency	
	84 cfm/watt



## 59138

Pewter Revival motor with Walnut Blades and Cased White glass

Inspired by the flower, a delicate balance between softness and rigidity elevates this fan to a level of charm rarely achieved by such a simple design.

### FEATURES

- Direct Drive™ motor / lifetime motor warranty
- 30" blade span
- Set of 3 pre-installed blades included
- 12" downrod included
- Minimum 9' ceiling required
- ETL rated for damp or humid locations
- Integrated LED light kit
- 172 x 12 motor

ORCHID



### MOTOR & BLADE FINISHES



A



B

#### A: 59137

Pewter Revival motor with Architectural White blades and Cased White Glass

#### B: 59138

Pewter Revival motor with Walnut blades and Cased White Glass

### CONTROLS



#### Included

**Universal Control**  
Four-speed wall control with full-range light dimming, reversing and CFL mode.



#### 99020 (optional)

**Universal Remote**  
Four-speed remote control with full-range light dimming, reversing and CFL mode.

### LIGHTING

Includes dimmable LED light kit.



#### Base:

Integrated LED

#### Wattage:

23 watts

#### Bulb Light Output:

2200 lumens

#### Correlated Color Temperature (CCT):

2700K

### DIMENSIONS AND ENERGY INFORMATION (AT HIGH SPEED)

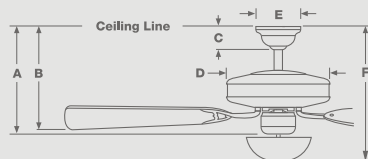

#### Dimensions\*

- A: —
- B: 21.05"
- C: 2.75"
- D: 11.14"
- E: 6.49"
- F: 23.74"

Airflow  
2,855 cfm

Electricity Use  
56-watt

Airflow Efficiency  
51 cfm/watt

\*with 12" downrod (included)

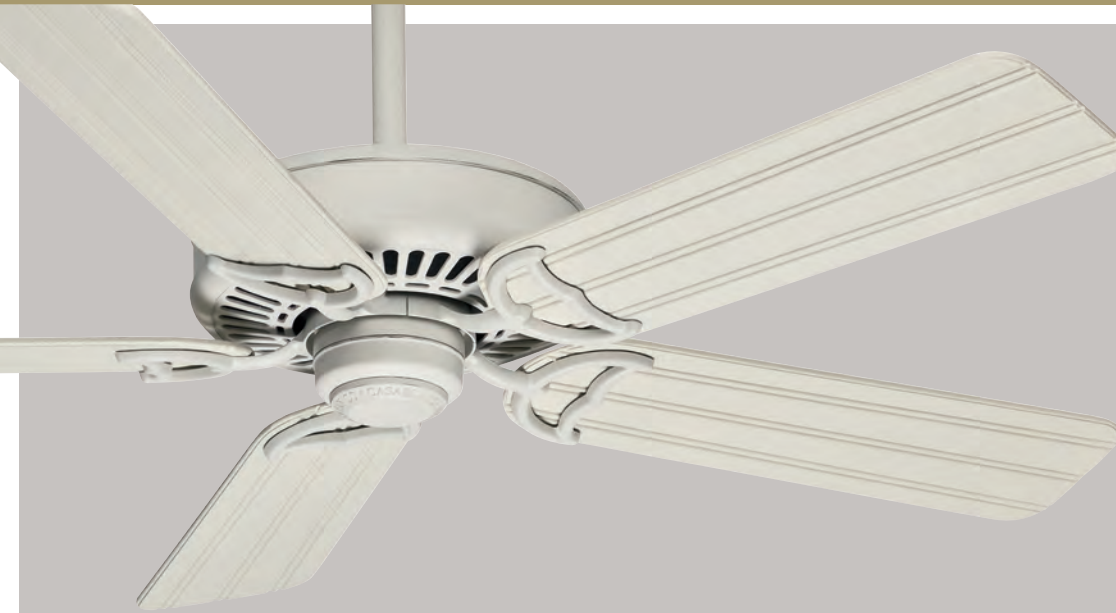

## 55031

Cottage White motor shown with 99014 Cottage White Beadboard All-Weather blades (sold separately)

With a timeless classic design, superb air movement, energy efficiency, and a variety of motor finishes, the Panama® Control has everything you could possibly want in a fan. It could be the only fan you would ever need.

### FEATURES

- Direct Drive™ motor / lifetime motor warranty
- 52"-58" blade span
- Multiple blade finish choices available (blades sold separately)
- Select models ETL rated for damp or humid locations
- 188 x 20 motor
- Light kits sold separately

# PANAMA® CONTROL



### MOTOR FINISHES



A



B



C

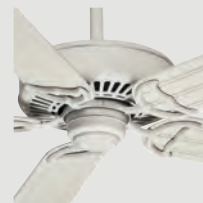

D

#### A: 55027

Snow White motor shown with 99021 Matte Snow White All-Weather blades

#### B: 55029

Aged Bronze motor shown with 99002 Burnt Walnut / Walnut Veneer blades

#### C: 55030

Brushed Cocoa motor shown with 99022 Cocoa All-Weather blades

#### D: 55031

Cottage White motor shown with 99014 Cottage White Beadboard All-Weather blades

### BLADES

Customize your fan with blades that reflect your style. Choose from a variety of finishes and shapes. See foldout on page 15.



### LIGHTING

Our design team's recommended lighting option.



#### 99089

Outdoor Four-Light fixture in Cottage White

For all other compatible light fixtures, see pages 127-130.

### CONTROLS



#### Included

Universal Control  
Four-speed wall control with full-range light dimming, reversing and CFL mode.



#### 99020 (optional)

Universal Remote  
Four-speed remote control with full-range light dimming, reversing and CFL mode.

### DIMENSIONS AND ENERGY INFORMATION (AT HIGH SPEED)

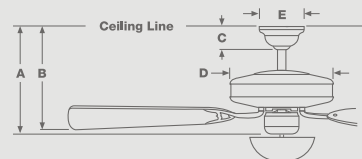

Dimensions	Airflow
A: 12.36"	7,375 cfm
B: 11.19"	Electricity Use
C: 2.75"	84-watt
D: 12.00"	Airflow Efficiency
E: 6.50"	88 cfm/watt
F: -	

\*Energy information based on 99004 blade set.

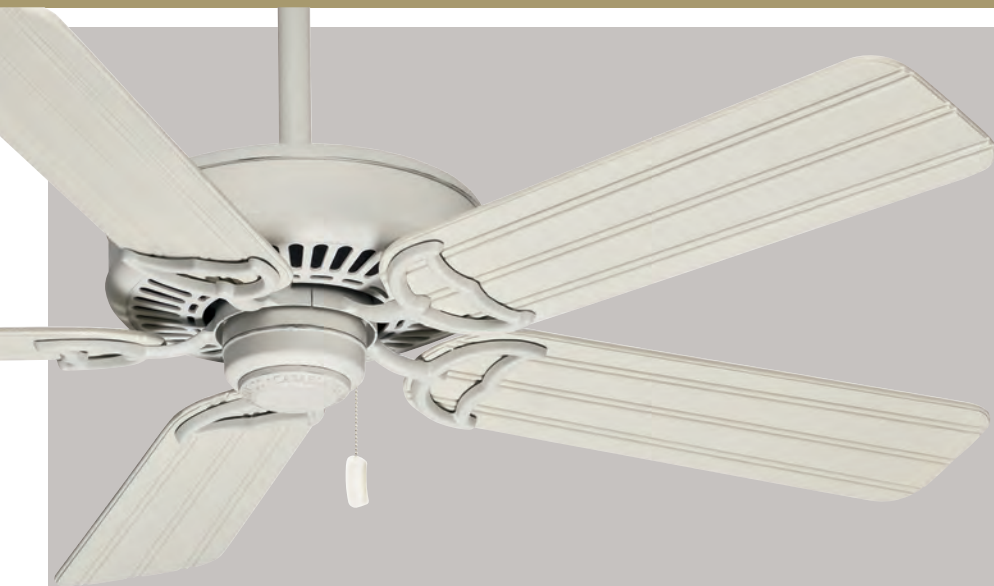

## 55025

Cottage White motor shown with 99014 Cottage White Beadboard All-Weather blades (sold separately)

All of the great features of the Panama® with an added pullchain. With a classic design, excellent air movement, energy efficiency, and a wide variety of motor and blade finishes, there is no need to look any further.

### FEATURES

- Direct Drive™ motor / lifetime motor warranty
- 52"-58" blade span
- Multiple blade finish choices available (blades sold separately)
- Select models ETL rated for damp or humid locations
- 188 x 20 motor
- Light kits sold separately

## PANAMA® PULLCHAIN



### MOTOR FINISHES



A



B



C

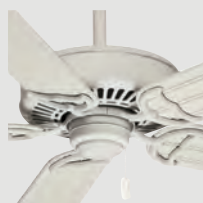

D

#### A: 55021

Snow White motor shown with 99021 Matte Snow White All-Weather blades

#### B: 55023

Aged Bronze motor shown with 99002 Burnt Walnut / Walnut veneer blades

#### C: 55024

Brushed Cocoa motor shown with 99022 Cocoa All-Weather blades

#### D: 55025

Cottage White motor shown with 99014 Cottage White Beadboard All-Weather blades

### BLADES

Customize your fan with blades that reflect your style. Choose from a variety of finishes and shapes. See foldout on page 15.



### LIGHTING

Our design team's recommended lighting option.



#### 99089

Outdoor Four-Light fixture in Cottage White

For all other compatible light fixtures, see pages 127-130.

### CONTROLS



**Included**  
4-Speed Pullchain



**99019 (optional)**  
Universal Control System  
Four-speed remote control and receiver with full-range light dimming and CFL mode.

### DIMENSIONS AND ENERGY INFORMATION (AT HIGH SPEED)

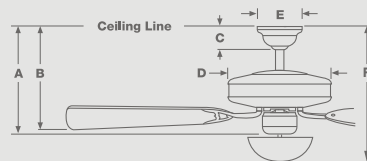

Dimensions	Airflow
A: 12.36"	7,264 cfm
B: 11.18"	Electricity Use
C: 2.75"	91-watt
D: 12.00"	Airflow Efficiency
E: 6.50"	80 cfm/watt
F: -	

\*Energy information based on 99004 blade set.





## 59168

Metallic SunSand motor with Drift Oak blades and Cased White Glass

Formal yet contemporary is a difficult balance to find, but the Perseus is a shining example. Named after the star constellation, this piece is inspired by 21st-century spacecraft design. The floating ring around the fan is something otherworldly, and this cosmic approach is carried throughout the design. The interplay between the earthly wood blades and the celestial metallic body is not quite like anything the world has seen before.

### FEATURES

- Direct Drive™ motor / lifetime motor warranty
- 64" blade span
- Set of 3 blades included
- 12" and 5" downrods included
- ETL rated for damp or humid locations
- Integrated LED light kit
- 188 x 20 motor

NEW

# PERSEUS



### MOTOR & BLADE FINISHES



A



B

#### A: 59167

Brushed Nickel motor with Walnut blades and Cased White Glass

#### B: 59168

Metallic SunSand motor with Drift Oak blades and Cased White Glass

### DOWNROD SLEEVES

#### Walnut Finish

- 99321** 14.5" sleeve for 18" downrod
- 99322** 20.5" sleeve for 24" downrod
- 99323** 32.5" sleeve for 36" downrod

#### Drift Oak Finish

- 99324** 14.5" sleeve for 18" downrod
- 99325** 20.5" sleeve for 24" downrod
- 99326** 32.5" sleeve for 36" downrod

### LIGHTING

Includes dimmable LED light kit.



#### Base:

Integrated LED

#### Wattage:

23 watts

#### LED Light Output:

2200 lumens

#### Correlated Color Temperature (CCT):

2700K

### CONTROLS



#### Included

**Universal Control**  
Four-speed wall control with full-range light dimming, reversing and CFL mode.



#### 99020 (optional)

**Universal Remote**  
Four-speed remote control with full-range light dimming, reversing and CFL mode.

### DIMENSIONS AND ENERGY INFORMATION (AT HIGH SPEED)

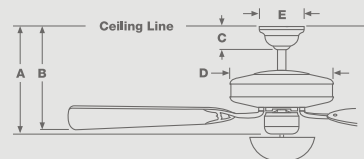

Dimensions*	Airflow
A: —	7,374 cfm
B: 18.26"	Electricity Use
C: 2.75"	88-watt
D: 14.60"	Airflow Efficiency
E: 6.49"	84 cfm/watt
F: 22.67"	

\*with 12" downrod (included)



## 59195

Brushed Slate motor with Coffee Beech Blades and Cased White glass

Taking cues from the early American Industrial Age, the clean lines and slick finishes combine with the mid-century blade design to provide a look that is undoubtedly modern.

### FEATURES

- Direct Drive™ motor / lifetime motor warranty
- 52" blade span
- Set of 3 blades included
- 3" and 2" downrods included
- Integrated LED light kit
- ETL rated for damp or humid locations
- 172 x 20 motor

PISTON



### MOTOR & BLADE FINISHES



A



B

#### A: 59195

Brushed Slate motor with Coffee Beech All-Weather Blades and Cased White Glass

#### B: 59196

Matte Black motor with Matte Black All-Weather Blades and Cased White Glass

### CONTROLS



#### Included

Universal Remote  
Four-speed remote control with full-range light dimming.

### LIGHTING

Includes dimmable LED light kit.



#### Base:

Integrated LED

#### Wattage:

17 watts

#### LED Light Output:

1500 lumens

#### Correlated Color Temperature (CCT):

2700K

### DIMENSIONS AND ENERGY INFORMATION (AT HIGH SPEED)

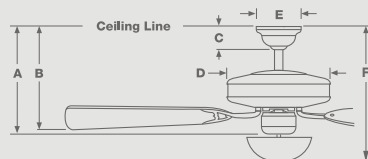

#### Dimensions

A: —  
B: 12.97"  
C: 2.75"  
D: 8.66"  
E: 6.49"  
F: 13.56"

#### Airflow

5,549 cfm

#### Electricity Use

82-watt

#### Airflow Efficiency

68 cfm/watt



## 54036

Aged Bronze motor with Dark Walnut All-Weather Blades

The versatile Utopian® fan is ideally suited for humid environments. Smooth contours and simple lines provide a clean, progressive look that enhances décor without distraction. For bathrooms, kitchens and verandas, the Utopian® is the perfect choice.

### FEATURES

- Direct Drive™ motor / lifetime motor warranty
- 52" blade span
- Set of 5 blades included
- ETL rated for damp or humid locations
- 172 x 20 motor
- Light kits sold separately

UTOPIAN®



### MOTOR & BLADE FINISHES



A



B



C

#### A: 54035

Brushed Cocoa motor with Distressed Antique Halifax All-Weather blades

#### B: 54036

Aged Bronze motor with Dark Walnut All-Weather blades

#### C: 54037

Snow White motor with Matte Snow White All-Weather blades

### CONTROLS



**Included**  
4-Speed Pullchain



**99019 (optional)**  
Universal Control System  
Four-speed remote control and receiver with full-range light dimming and CFL mode.

### LIGHTING

Our design team's recommended lighting option.



#### 99079

Low Profile Fitter in Aged Bronze

#### 99084

Low Profile Glass in Toffee

For all other compatible light fixtures, see pages 127-130.

### DIMENSIONS AND ENERGY INFORMATION (AT HIGH SPEED)

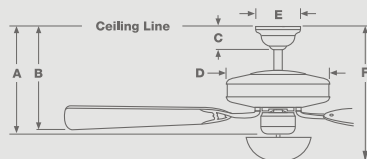

Dimensions	Airflow
A: 12.86"	6,424 cfm
B: 11.64"	Electricity Use
C: 2.75"	81-watt
D: 11.24"	Airflow Efficiency
E: 6.49"	79 cfm/watt
F: -	



## 54039

Brushed Cocoa motor with  
Antique Halifax All-Weather blades

With a clean, progressive design, it has everything that is attractive about the Utopian® fan but adds a bowl light and four-speed wall-mount control. It is ideal for humid environments.

### FEATURES

- Direct Drive™ motor / lifetime motor warranty
- 52" blade span
- Set of 5 blades included
- Includes bowl light fixture with three 60-watt candelabra incandescent bulbs
- ETL rated for damp or humid locations
- 172 x 20 motor

## UTOPIAN® GALLERY



### MOTOR & BLADE FINISHES



A



B



C

#### A: 54039

Brushed Cocoa motor with Distressed  
Antique Halifax All-Weather blades  
and Tea Stain glass

#### B: 54040

Aged Bronze motor with Dark  
Walnut All-Weather blades  
and Champagne Scavo glass

#### C: 54041

Snow White motor with Matte  
Snow White All-Weather blades  
and Cased White glass

### CONTROLS



#### Included

Universal Control  
Four-speed wall control with  
full-range light dimming,  
reversing and CFL mode.



#### 99020 (optional)

Universal Remote  
Four-speed remote control  
with full-range light dimming,  
reversing and CFL mode.

### DIMENSIONS AND ENERGY INFORMATION (AT HIGH SPEED)

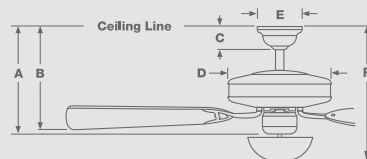

#### Dimensions

A:	12.86"
B:	11.64"
C:	2.75"
D:	11.24"
E:	6.49"
F:	18.33"

Airflow  
**6,504 cfm**

Electricity Use  
**84-watt**

Airflow Efficiency  
**77 cfm/watt**



## 59155

Satin Nickel motor with reversible Platinum / Black Mahogany blades and Cased White glass

The sleek, triple-bladed Verse is all about the simple comfort expressed by its minimal design. With a strong emphasis on clean lines and subtle form, the Verse provides inspiration to any contemporary, transitional, or casual setting.

### FEATURES

- Direct Drive™ motor / lifetime motor warranty
- 44" blade span
- Set of 3 exclusive blades included
- Includes optional no-light cap
- Integrated 16-watt LED light kit
- ETL rated for damp or humid locations
- 172 x 12 motor



Includes low profile mounting kit (see page 99)



Includes optional no-light cap

## VERSE 44"



### MOTOR & BLADE FINISHES



A



B



C

#### A: 59153

Fresh White motor with Fresh White blades and Cased White glass

#### B: 59154

Maiden Bronze motor with reversible Maiden Bronze / Espresso blades and Cased White glass

#### C: 59155

Satin Nickel motor with reversible Platinum / Black Mahogany blades and Cased White glass

### CONTROLS



**Included**  
Universal Remote  
Four-speed remote control with full-range light dimming.

### LIGHTING

Includes dimmable LED light kit.



#### Base:

Integrated LED

**Wattage:**

16 watts

**LED Light Output:**

1300 lumens

**Correlated Color**

**Temperature (CCT):**

3000K

### DIMENSIONS AND ENERGY INFORMATION (AT HIGH SPEED)

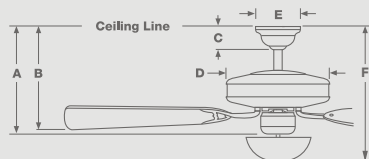

#### Dimensions

A:	—
B:	10.15"
C:	2.75"
D:	11.79"
E:	6.49"
F:	14.06"

Airflow  
**4,159 cfm**

Electricity Use  
**57-watt**

Airflow Efficiency  
**73 cfm/watt**



## 59158

Fresh White motor with Fresh White blades and Cased White glass

The sleek, triple-bladed 54" Verse has the same minimal design as the smaller version but is intended for larger spaces. With a strong emphasis on clean lines and subtle form, the Verse provides inspiration to any contemporary, transitional, or casual setting.

### FEATURES

- Direct Drive™ motor / lifetime motor warranty
- 54" blade span
- Set of 3 exclusive blades included
- Includes optional no-light cap
- Integrated 16-watt LED light kit
- ETL rated for damp or humid locations
- 172 x 20 motor



Includes low profile mounting kit (see page 100)



Includes optional no-light cap

## VERSE 54"



### MOTOR & BLADE FINISHES



#### A: 59158

Fresh White motor with Fresh White blades and Cased White glass

#### B: 59159

Maiden Bronze motor with reversible Maiden Bronze / Espresso blades and Cased White glass

#### C: 59160

Satin Nickel motor with reversible Platinum / Black Mahogany blades and Cased White glass

### CONTROLS



#### Included

Universal Remote  
Four-speed remote control with full-range light dimming.

### LIGHTING

Includes dimmable LED light kit.



#### Base:

Integrated LED

#### Wattage:

16 watts

#### LED Light Output:

1300 lumens

#### Correlated Color Temperature (CCT):

3000K

### DIMENSIONS AND ENERGY INFORMATION (AT HIGH SPEED)

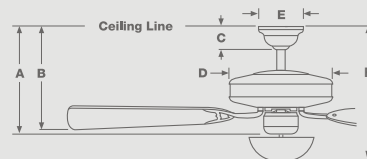

#### Dimensions

- A: —
- B: 10.15"
- C: 2.75"
- D: 11.79"
- E: 6.49"
- F: 14.06"

Airflow  
5,987 cfm

Electricity Use  
78-watt

Airflow Efficiency  
77 cfm/watt



## 59525

Brushed Cocoa motor with Dark Walnut All-Weather blades

The ETL damp-rated Wailea® fan, inspired by Casablanca's popular Capistrano® fan, is perfectly suited for small spaces. This 31 inch wide fan is ideal for bathrooms, laundry rooms, walk-in closets, and kitchens where ventilation is needed.

### FEATURES

- Direct Drive™ motor / lifetime motor warranty
- 31" blade span / 25° blade pitch (optimized for maximum air movement)
- Set of 6 exclusive All-Weather ABS blades included
- Moisture-resistant motor / stainless steel hardware
- Use only damp- or wet-rated light fixtures in damp locations
- 172 x 12 motor
- Light kits sold separately

WAILEA®



### MOTOR & BLADE FINISHES

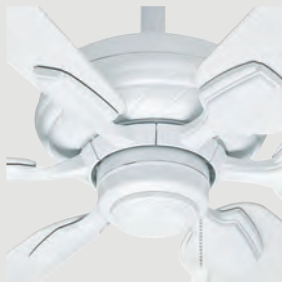

A



B



C

#### A: 59523

Snow White motor with Snow White All-Weather blades

#### B: 59524

Brushed Nickel motor with Dark Walnut All-Weather blades

#### C: 59525

Brushed Cocoa motor with Dark Walnut All-Weather blades

### CONTROLS



**Included**  
4-Speed Pullchain



#### 99019 (optional)

Universal Control System  
Four-speed remote control and receiver with full-range light dimming and CFL mode.

### LIGHTING

Our design team's recommended lighting option.



#### 99025

Ultra-Bright Bowl light

#### 99060

Toffee Glass Bowl

For all other compatible light fixtures, see pages 127-130.

### DIMENSIONS AND ENERGY INFORMATION (AT HIGH SPEED)

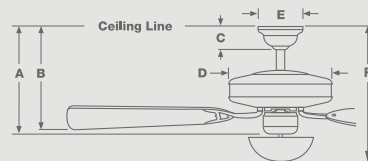

#### Dimensions

A:	12.71"
B:	11.26"
C:	3.00"
D:	8.50"
E:	5.60"
F:	-

#### Airflow

3,055 cfm

Electricity Use  
63-watt

Airflow Efficiency  
48 cfm/watt



FOUR-LIGHT KIT





ACCESSORIES

OUTDOOR FOUR-LIGHT FIXTURES



A



B



C



D



E

OUTDOOR FOUR-LIGHT FIXTURE

- Includes four 14-watt medium-based CFL bulbs
- ETL rated for wet locations



- A: **99087**  
Aged Bronze with Tea Stain glass
- B: **99088**  
Snow White with Cased White glass
- C: **99089**  
Cottage White with Cased White glass
- D: **99090**  
Brushed Cocoa with Cased White glass
- E: **99091**  
Maiden Bronze with Cased White glass

FOUR-LIGHT FITTER & GLASS



A



B



C



D



E



F



G



H



I



J



K



L

FOUR-LIGHT FITTER

Add style and ambiance to your room with a custom light kit. Simply select the four-light fitter that matches your fan's finish, then choose your desired side glass from the selection below.

- Includes four 14-watt medium-based CFL bulbs
- Glass sold separately

A: 99033

Maiden Bronze

Other available finishes:

- 99029 Snow White
- 99030 Basque Black
- 99031 Cottage White
- 99032 Antique Brass
- 99033 Maiden Bronze
- 99034 Aged Bronze
- 99103 Brushed Nickel
- 99104 Provence Crackle
- 99105 Brushed Cocoa

FOUR-LIGHT FITTER 2 1/4" SIDE GLASS

- Includes set of four
- Fitter sold separately

B: 99035

Bell Shape glass in Cased White

C: 99036

Bell Shape glass in Amber Linen

D: 99037

Bell Shape glass in Swirled Marble

E: 99038

Bell Shape glass in Toffee

F: 99039

Square Shape glass in Cased White

G: 99040

Square Shape glass in Frosted Amber Speckled

H: 99041

Slanted Shape glass in Cased White

I: 99042

Rounded Step Shape glass in Cased White

J: 99043

Rounded Step Shape glass in Tea Stain

K: 99044

Ribbed Deco Shape glass in Cased White

L: 99045

Ribbed Deco Shape glass in Toffee

For all compatible light fixtures, see pages 131-132.

LOW PROFILE FITTERS & GLASS



**A: Incandescent Low Profile Fitter**

- Includes two 60-watt candelabra bulbs
- Glass sold separately (see D-H below)
- ETL rated for wet locations



**Available finishes:**

- 99075 Cottage White
- 99076 Snow White
- 99077 Maiden Bronze (shown)
- 99078 Brushed Cocoa
- 99079 Aged Bronze
- 99080 Brushed Nickel (Indoor only)

**B: CFL Low Profile Fitter**

- Includes two 13-watt GU24 CFL bulbs
- Glass sold separately (see D-H below)

**Available finishes:**

- 99252 Antique Brass
- 99253 Snow White (shown)
- 99254 Brushed Nickel
- 99255 Brushed Cocoa
- 99256 Maiden Bronze



**C: CFL Circline Low Profile Fitter**

- Includes one 27-watt circline fluorescent bulb
- Glass sold separately (see D-H below)

\* Discontinued. While supplies last.

**Available finishes:**

- 99065 Antique Brass
- 99066 Snow White (shown)
- 99067 Brushed Nickel
- 99068 Brushed Cocoa
- 99069 Maiden Bronze



**Low Profile Glass**

- Fitter sold separately (see A-C above)

- D: 99072** Shallow shape glass in Cased White
- E: 99073** Recessed shape glass in Cased White
- F: 99082** Standard shape glass in Cased White
- G: 99083** Stepped shape glass in Cased White
- H: 99084** Stepped shape glass in Toffee

LOW PROFILE BOWL LIGHT FIXTURE



**Low Profile Bowl Light Fixture**

- Includes three 14-watt medium-based CFL bulbs
- ETL rated for damp or humid locations



**A: 99258**

Swirled Marble Glass comes with Cap and Finials in Brushed Nickel, Snow White, Cottage White, and Brushed Cocoa

**B: 99259**

White Cased Glass comes with Cap and Finials in Brushed Nickel, Snow White, Cottage White, and Brushed Cocoa

**C: 99260**

Toffee Glass comes with Cap and Finials in Brushed Cocoa, Antique Brass, and Maiden Bronze

**Low Profile Cap and Finial Packs**

(not shown-sold separately)

- 99265 Antique Brass
- 99266 Maiden Bronze
- 99267 Aged Bronze

BOWL FITTERS & GLASS



**A: 99023 CFL Bowl Fitter**

- Bowl Fitter, 28 watts
- Includes two 14-watt medium-based CFL bulbs
- Includes cap and finials in Brushed Cocoa, Brushed Nickel, and Snow White
- Glass sold separately

**B: 99025 Ultra-Bright Bowl Light Fitter**

- Includes three 23-watt medium-based CFL bulbs
- Includes cap and finials in Brushed Nickel, Snow White, and Brushed Cocoa
- ETL rated for damp or humid locations
- Glass sold separately



**C: 99183 LED Bowl Fitter**

- Includes 16-watt LED module
- Includes cap and finials in Brushed Cocoa, Brushed Nickel, and Snow White
- LED light output: 1200 lumens
- Correlated color temperature (CCT): 3000K
- 10 Year warranty
- Glass sold separately



**D: 99057 Swirled Marble Glass Bowl**

**E: 99058 Tea Stain Glass Bowl**

**F: 99059 Cased White Glass Bowl**

**G: 99060 Toffee Glass Bowl**

**H: 99061 Cased White Glass Bowl**

**I: 99062 Toffee Glass Bowl**

**J: 99063 Tropical Leaf Glass Bowl**

**Bowl Cap and Finial Packs (not shown)**

- 99128 Cottage White
- 99129 Aged Bronze
- 99130 Maiden Bronze
- 99131 Antique Brass
- 99132 Provence Crackle
- 99133 Industrial Rust

COMPLETE GLOBE LIGHT FIXTURES



**Incandescent Globe Light Fixture**

- Includes two 60-watt candelabra bulbs
- Includes globe fixture with Cased White glass

**Available finishes:**







- 99050 Snow White (shown)
- 99051 Brushed Nickel
- 99052 Brushed Cocoa
- 99053 Maiden Bronze
- 99054 Aged Bronze
- 99055 Antique Brass

For all compatible light fixtures, see pages 131-132.

- Compatible for Indoor Use only
- ▲ Compatible for Indoor or Damp Environments
- \* Compatible for Indoor, Damp or Wet Environments

NOTE: Lightbulbs included with light fixtures.

**Bold models are offered on a "While Supplies Last" basis.**

	Model	Description	Bulbs
<b>FOUR-LIGHT FIXTURES &amp; FITTERS</b>			
	99087	Outdoor Four-Light Fixture, Aged Bronze with Tea Stain glass	CFL
	99088	Outdoor Four-Light Fixture, Snow White with Cased White glass	CFL
	99089	Outdoor Four-Light Fixture, Cottage White with Cased White glass	CFL
	99090	Outdoor Four-Light Fixture, Brushed Cocoa with Cased White glass	CFL
	99091	Outdoor Four-Light Fixture, Maiden Bronze with Cased White glass	CFL
	99029	Four-Light Fitter, Snow White	CFL
	99030	Four-Light Fitter, Basque Black	CFL
	99031	Four-Light Fitter, Cottage White	CFL
	99032	Four-Light Fitter, Antique Brass	CFL
	99033	Four-Light Fitter, Maiden Bronze	CFL
	99034	Four-Light Fitter, Aged Bronze	CFL
	99103	Four-Light Fitter, Brushed Nickel	CFL
	99104	Four-Light Fitter, Provence Crackle	CFL
	99105	Four-Light Fitter, Brushed Cocoa	CFL
	<i>Glass sold separately (see page 128)</i>		
<b>LOW PROFILE FITTERS</b>			
	99065	<b>Low Profile Fitter, Antique Brass</b>	<b>Circ-line CFL</b>
	99066	<b>Low Profile Fitter, Snow White</b>	<b>Circ-line CFL</b>
	99067	<b>Low Profile Fitter, Brushed Nickel</b>	<b>Circ-line CFL</b>
	99068	<b>Low Profile Fitter, Brushed Cocoa</b>	<b>Circ-line CFL</b>
	99069	<b>Low Profile Fitter, Maiden Bronze</b>	<b>Circ-line CFL</b>
<i>Glass sold separately (see page 129)</i>			
	99252	Low Profile Fitter, Antique Brass	GU-24 base CFL
	99253	Low Profile Fitter, Snow White	GU-24 base CFL
	99254	Low Profile Fitter, Brushed Nickel	GU-24 base CFL
	99255	Low Profile Fitter, Brushed Cocoa	GU-24 base CFL
	99256	Low Profile Fitter, Maiden Bronze	GU-24 base CFL
	99075	Low Profile Fitter, Wet-Rated, Cottage White	Incandescent
99076	Low Profile Fitter, Wet-Rated, Snow White	Incandescent	
99077	Low Profile Fitter, Wet-Rated, Maiden Bronze	Incandescent	
99078	Low Profile Fitter, Wet-Rated, Brushed Cocoa	Incandescent	
99079	Low Profile Fitter, Wet-Rated, Aged Bronze	Incandescent	
99080	Low Profile Fitter, Brushed Nickel (Indoor only)	Incandescent	
<i>Glass sold separately (see page 129)</i>			
<b>BOWL FITTERS</b>			
	99023	CFL Bowl Fitter	CFL
	99183	LED Bowl Fitter	LED
	99025	Ultra-Bright Bowl Light Fitter	CFL
<i>Glass sold separately (see page 130)</i>			
<b>LOW PROFILE BOWL LIGHT FIXTURES</b>			
	99258	Low Profile Bowl Fixture, Damp-Rated, with Swirled Marble Glass	CFL
	99259	Low Profile Bowl Fixture, Damp-Rated, with Cased White Glass	CFL
	99260	Low Profile Bowl Fixture, Damp-Rated, with Toffee Glass	CFL
<b>COMPLETE GLOBE LIGHT FIXTURES</b>			
	99050	Globe Fixture, Snow White with Cased White glass	Incandescent
	99051	Globe Fixture, Brushed Nickel with Cased White glass	Incandescent
	99052	Globe Fixture, Brushed Cocoa with Cased White glass	Incandescent
	99053	Globe Fixture, Maiden Bronze with Cased White glass	Incandescent
	99054	Globe Fixture, Aged Bronze with Cased White glass	Incandescent
	99055	Globe Fixture, Antique Brass with Cased White glass	Incandescent



DOWNRODS

	DOWNROD LENGTH							
	12"	18"	24"	36"	48"	60"	72"	96"
Acadia	99235	99236	99237	99238	99239	99240	99241	
Aged Bronze	64533	64534	64535	64537	64538	64539	99243	
Aged Steel	Use Matte Black for this finish							
Antique Brass	63009	63010	63011	63013	63014	63015	63129	
Antique Pewter	28054	28055	28056	28057	28058	28059	28060	
Architectural White	63352	63353	63354	63356	63357	63358	63359	
Basque Black	Use Matte Black for this finish							
Bright Brass	63001	63002	63003	63005	63006	63007	63128	
Bronze Patina	28206	28207	28208	28209	28210			
Brushed Cocoa	64525	64526	64527	64529	64530	64531	99242	
Brushed Nickel	26019	26020	26021	26022	26023	26024	26025	63266
Brushed Slate	99287	99288	99289	99290	99291	99292	99293	
Bullion Black	64612	64613	64614	64616	64617	64618		
Cottage White	99200	99201	99202	99203	99204	99205	99206	
Fresh White	Use Snow White for this finish							
Granite	99356	99357	99358	99359	99360	99361	99362	
Graphite	62428	62429	62430	62432	62433		62435	
Industrial Rust	99244	99245	99246	99247	99248	99249	99250	
Maiden Bronze	99207	99208	99209	99210	99211	99212	99213	
Matte Black	63025	63026	63027	63029	63030	63031	63131	
Metallic Birch	99328	99329	99330	99331	99332	99333	99334	
Metallic Chocolate	99335	99336	99337	99338	99339	99340	99341	
Metallic SunSand	99349	99350	99351	99352	99353	99354	99355	
Oil-Rubbed Bronze	<b>63505</b>	<b>63510</b>	<b>63515</b>	<b>63525</b>	<b>63530</b>	<b>63535</b>	<b>63540</b>	<b>63350</b>
Onyx Bengal	99221	99222	99223	99224	99225	99226	99227	
Pewter	99311	99312	99313	99314	99315	99316	99317	
Pewter Revival	99342	99343	99344	99345	99346	99347	99348	
Porcelain White	Use Architectural White for this finish							
Provence Crackle	99228	99229	99230	99231	99232	99233	99234	
Satin Nickel	99271	99272	99273	99274	99275	99276	99277	
Snow White	63049	63050	63051	63053	63054	63055	63133	63156
Tahoe	Use Brushed Cocoa or New Bronze for this finish							

Note: Bold numbers available while supplies last.

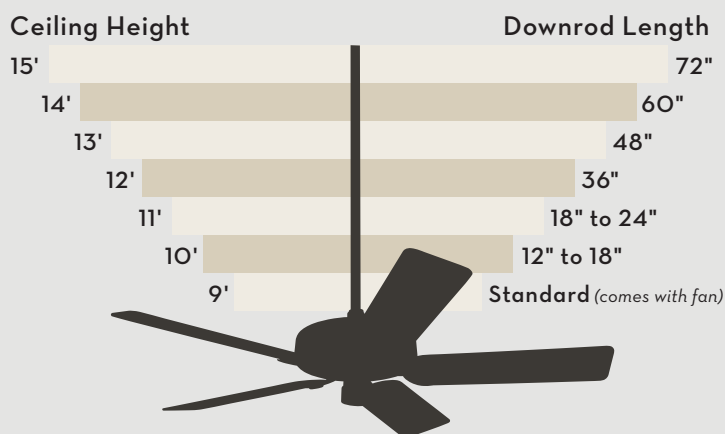

Note: For best performance and appearance, an extension downrod should be used with your Casablanca fan when installing on a high or sloped ceiling. Casablanca offers extension downrods in lengths up to 8' (96"). The chart lists the most common ceiling heights and suggested downrod lengths. For safety reasons, the fan blades must be a minimum of 7 feet above the floor. For more information, see your Casablanca dealer.

**Sloped Ceiling Adapter (SCA-P)**

The Casablanca Sloped Ceiling Adapter provides an easy way to hang your Casablanca ceiling fan from an angled ceiling. Designed for ceilings at an angle between 32 degrees and 56 degrees, the Sloped Ceiling Adapter works with the hanging system that comes with your ceiling fan to ensure the safe operation that you expect from Casablanca.



Sloped Ceiling Adapter (SCA)



INTEGRATED CONTROLS

With simple two-wire installation and intuitive integrated controls designed exclusively for—and included with—specific fan models, Casablanca fans are easy to install and even easier to use. The integrated controls are available in wall-mounted or hand-held models and offer adjustable fan speed, direction settings, and lighting levels. Select models also offer the following advanced programmable features for total environmental enhancement:

**Safe-Exit™** – provides 20 seconds of gradual light dimming, showing you safely to the door

**Home-Safe™** – controls lights in an irregular sequence, making a home appear occupied

**Fan Minder™** – incrementally reduces fan speed to maintain comfort at night

**Light Minder™** – saves energy by turning lights off automatically after two hours



A



B



C



D

**A: Universal Control (K022301000)**

- Wall-mounted control only
- Battery-powered
- Four forward and reverse fan speeds
- Full-range light dimming
- CFL auto detect
- Damp Rated
- Safe-Exit™

**B: DC 6-Speed**

- Hand-held remote
- Six forward and reverse fan speeds
- Full-range light dimming

**C: Intelli-Touch3® (W-85 Single Light)**

- Wall-mounted control
- Six forward and reverse fan speeds
- Full-range light dimming
- Safe-Exit™
- Home-Safe™
- Fan Minder™
- Light Minder™

**D: Three-Speed Stepped Control**

- Wall-mounted control
- Three fan speeds
- Installs in standard two-wire wall switch
- Uses standard switch-plate (not included)

ACCESSORY CONTROLS

Casablanca offers a complete line of optional accessory controls that allow homeowners to optimize the functionality of their fans on personal preferences.



A



B

**A: Universal Control System (99019)**

- Hand-held remote and canopy-mount receiver
- Four forward fan speeds
- Full-range light dimming
- CFL auto detect
- Damp Rated

*Compatible with all 5xxxx fans.*

**B: Universal Remote (99020)**

- Hand-held remote only
- Four forward and reverse fan speeds
- Full-range light dimming
- CFL auto detect
- Damp Rated

*Compatible with all 5xxxx fans.*

CEILING FAN SPECIFICATIONS

Series	Model Number (x, xx, or xxx = Finish Code)	Page Number	Dimensions (in inches)						Blade Pitch
			A	B	C	D	E	F	
Academy (with 99004 blade set)	54083-54085	17	13.11	10.95	2.75	13.72	6.49	-	13°
Academy Gallery	54080, 54081	47	13.11	10.95	2.75	13.72	6.49	18.32	13°
Adelaide (with 99004 blade set)	54116-54118	18	13.11	11.70	2.75	13.99	6.49	-	13°
Ainsworth 54"	54000-54002	33	13.11	11.73	2.75	12.41	6.49	-	13°
Ainsworth 60"	55000-55002	34	13.11	11.73	2.75	12.41	6.49	-	13°
Ainsworth Gallery 54"	54005-54007	35	13.11	11.73	2.75	12.41	6.49	19.56	13°
Ainsworth Gallery 60"	55005-55007	36	13.11	11.73	2.75	12.41	6.49	18.88	13°
Areto (with 99004 blade set)	54120-54122	19	13.11	11.74	2.75	10.50	6.49	-	13°
Aris	59123, 59124	63, 103	14.69	12.78	2.75	8.74	6.49	-	13°
Atria	64395	48, 104	23.40	28.80	3.00	17.10	5.60		11°
Bel Air	59076-59078	49	-	9.86	2.75	12.19	6.49	14.29	14°
Brescia Control (with 99004 blade set)	55019, 55020	20	12.12	10.54	2.75	14.04	6.49	-	13°
Brescia Pullchain (with 99004 blade set)	55015, 55016	21	12.12	10.54	2.75	14.04	6.49	-	13°
Bullet	59068-59070	64	-	20.86	2.75	8.08	6.49	24.03	14°
Caledonia	54105, 54106	93	9.15	7.97	-	12.50	-	15.02	13°
Caneel Bay	59113, 59114	50, 105	-	13.04	2.75	10.03	6.49	16.79	13°
Capistrano (with 99004 blade set)	54028-54030	22, 106	13.12	11.67	2.75	12.50	6.50		13°
Capistrano Gallery	54031-54033	37	13.12	11.67	2.75	12.50	6.50	19.00	13°
Charthouse (with 99004 blade set)	55010-55012	23, 107	13.13	11.92	2.75	12.50	6.49		13°
Coletti (with 99004 blade set)	55054-55056	24	13.11	11.69	2.75	13.27	6.49	-	13°
Compass Point (with 99004 blade set)	54010, 54011	25, 108	13.11	11.58	2.75	9.17	6.49	-	13°
Concentra	54019-54021	38	13.12	11.39	2.75	12.50	6.49	-	13°
Concentra Gallery	54022-54025	39	13.12	11.39	2.75	12.50	6.49	18.77	13°
Correne	59197, 59198	65	-	10.19	2.75	11.42	6.49	13.50	13°
Crestmont (with 99004 blade set)	55063-55065	26, 109	12.50	11.77	2.75	13.08	6.49	-	13°
Duluth 60"	59191, 59192	67, 110	22.32	21.46	2.75	10.67	6.49	-	16°
Duluth 72"	59193, 59194	68, 111	22.32	21.46	2.75	10.67	6.49	-	16°
Durant 44"	53187, 53188	94	8.90	7.75	-	12.50	-	14.80	13°
Durant 54"	54101, 54102	95	8.90	7.81	-	12.50	-	14.80	13°
Durant 54" (no light)	54103	96	8.90	7.81	-	12.50	-	-	13°
Fellini	55035, 55036	51	14.96	12.50	2.75	14.20	6.49	-	13°
Fellini DC	59518	52	15.13	11.88	2.75	14.20	6.49	-	13°
Fordham	53194, 53195	40	12.61	10.88	2.75	10.08	6.49	4.57	13°
Glen Arbor	59162, 59163	53	-	8.94	2.75	8.73	6.49	17.70	13°

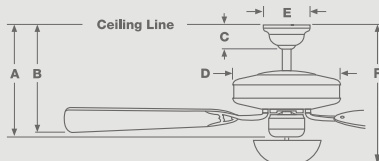

Energy measurements taken with included or exclusive blades unless noted otherwise.  
 \* Energy measurements taken with 21" basic blades

Blade Span		Weight (lb.)	Min. Ceiling Height (ft.)	Energy Information (at High Speed)				Motor Size	Fan Control
Long	Short			Speed (rpm)	Airflow (cfm)	Electricity Use (watts)	Airflow Efficiency (cfm/watt)		
60"	54"	25	8	150	7,156	80.40	89.01	172mm x 20mm	4 speed pullchain
54"		29	8	185	6,546	80.00	82.00	172mm x 20mm	4 speed pullchain
60"	54"	15	8	153	6,289	80.40	78.23	172mm x 20mm	4 speed pullchain
54"		23	8	174	6,125	77.80	79.00	172mm x 20mm	4 speed pullchain
60"		24	8	145	7,093	83.00	85.50	188mm x 20mm	4 speed pullchain
54"		28	8	174	6,125	78.00	78.74	172mm x 20mm	4 speed pullchain
60"		29	8	146	7,204	86.00	83.40	188mm x 20mm	4 speed wall control
60"	54"	16	8	155	6,200	82.00	75.40	172mm x 20mm	4 speed pullchain
54"		21	8	121	6,196	82.00	75.50	172mm x 20mm	4 speed wall control
68"		42	9	156	9,042	93.00	97.40	XTR200 - 30mm	4-S W-81
56"		23	8	164	7,133	86.00	83.00	188mm x 20mm	4 speed wall control
60"	54"	27	8	162	7,282	88.00	83.00	188mm x 20mm	4 speed wall control
60"	54"	27	8	162	7,533	86.00	87.70	188mm x 20mm	4 speed pullchain
54"		22	9	171	6,486	84.50	76.70	172mm x 20mm	4 speed wall control
54"		24	8	162	4,388	78.30	56.00	172mm x 20mm	4 speed pullchain
56"		29	9	177	6,585	87.40	75.35	188mm x 20mm	4 speed wall control
60"	54"	24	8	133	6,496	82.50	78.70	172mm x 20mm	4 speed pullchain
54"		31	8	187	5,965	83.10	71.80	172mm x 20mm	4 speed wall control
60"	54"	24	8	157	7,206	86.00	83.40	188mm x 20mm	4 speed pullchain
60"	54"	22	8	165	6,626	86.00	77.10	188mm x 20mm	4 speed pullchain
60"	54"	23	8	146	6,590	83.00	80.00	172mm x 20mm	4 speed pullchain
54"		27	8	175	6,129	81.20	75.70	172mm x 20mm	4 speed pullchain
54"		31	8	180	6,129	80.70	76.00	172mm x 20mm	4 speed pullchain
56"		23	8	209	7,152	85.70	83.50	172mm x 20mm	4 speed remote
60"	54"	20	8	171	6,519	86.10	75.71	188mm x 20mm	4 speed wall control
60"		44	9	193	7,988	112.50	71.00	212mm x 35mm	3 speed wall control
72"		46	9	126	9,475	110.30	85.90	212mm x 35mm	3 speed wall control
44"		19	8	246	3,375	61.00	55.30	172mm x 12mm	4 speed pullchain
54"		22	8	145	4,249	81.00	53.00	172mm x 20mm	4 speed pullchain
54"		17	8	143	4,412	82.00	54.00	172mm x 20mm	4 speed pullchain
60"		29	8	130	6,351	87.00	72.90	188mm x 20mm	4 speed wall control
66"		19	8		8,651	34.80	248.60	165 DC	DC 6 speed
44"		15	8	254	4,955	64.20	77.19	172mm x 12mm	4 speed pullchain
56"		34	8	190	6,600	80.20	82.30	172mm x 20mm	4 speed remote

Technology:  
 I-T = Intelli-Touch  
 4-S = Four Speed  
 D-T = Direct-Touch  
 DC = DC 6-speed

CEILING FAN SPECIFICATIONS (CONTINUED)

Series	Model Number (x, xx, or xxx = Finish Code)	Page Number	Dimensions (in inches)						Blade Pitch
			A	B	C	D	E	F	
Heathridge	55051, 55052	55,113	13.12	11.76	2.75	15.21	6.49	20.32	13°
Heritage	59527, 59528	56, 114	13.02	11.97	2.75	15.96	6.49	-	13°
Holliston (with 99004 blade set)	59532-59535	27	12.47	10.50	2.75	13.94	6.49	-	14°
Holliston Gallery	59536, 59537	57	12.47	10.50	2.75	13.94	6.49	19.94	14°
Isotope 44"	59018-59020	97	-	9.59	-	10.20	-	12.76	14°
Isotope 52"	59021-59023	98	-	9.59	-	10.20	-	12.76	14°
Orchid	59137, 59138	69, 115	-	21.05	2.75	11.14	6.49	23.74	N/A
Panama Control (with 99004 blade set)	55027-55032	28, 116	11.20	12.40	2.75	12.00	6.50	-	13°
Panama DC	59510-59512	41	13.29	11.69	2.75	12.00	6.49	-	13°
Panama Gallery	55058-55061	42	10.86	12.37	2.75	12.00	6.49	19.17	13°
Panama Pullchain (with 99004 blade set)	55021-55026	29,117	11.20	12.40	2.75	12.00	6.50	-	13°
Panama XLP Control (with 99004 blade set)	59095-59098	30	13.07	11.90	2.75	12.00	6.49	-	15°
Perseus	59167, 59168	71, 118	-	18.26	2.75	14.60	6.49	22.67	N/A
Piston	59195, 59196	73, 119	-	12.97	2.75	8.66	6.49	13.56	13°
Riello	59119, 59121	75	-	11.47	2.75	11.73	6.49	12.40	15°
Stealth	59090-59094	76	-	11.24	2.75	11.06	6.49	13.98	14°
Stealth DC	59105-59107	77	-	11.24	2.75	11.06	6.49	13.98	14°
Stealth DC LED	59164, 59165	78	-	11.24	2.75	11.06	6.49	13.98	14°
Stingray	59143, 59144	79	19.00	18.29	2.75	12.62	6.49	19.00	N/A
Tercera	59064, 59065	81	-	11.30	2.75	12.94	6.49	13.71	15°
Tribeca 52"	59500, 59501	82	17.96	17.27	2.75	7.50	6.49	-	16°
Tribeca 60"	59503-59505	83	17.96	17.30	2.75	7.50	6.49	-	16°
Trident	59081-59083	84	-	10.08	2.75	10.20	6.49	14.15	14°
Utopian	54035-54038	58, 120	12.86	11.64	2.75	11.24	6.49	-	13°
Utopian Gallery	54039-54042	59, 121	12.86	11.64	2.75	11.24	6.49	18.33	13°
Verse 44"	59153-59155	85, 99, 122	-	10.15	2.75	11.79	6.49	14.06	12°
Verse 54"	59158-59160	86, 100, 123	-	10.15	2.75	11.79	6.49	14.06	12°
Victorian	60129	43	11.50	13.50	3.00	13.00	5.60	-	15°
Wailea	59523-59525	44, 124	11.34	11.93	3.00	8.50	5.60	-	25°
Whitman	59059, 59061, 59062	60	-	11.54	2.75	13.10	6.49	17.00	14°
Wisp 44"	59149, 59150	87	-	12.08	2.75	8.65	6.49	13.96	16°
Wisp 52"	59151, 59152	89	-	12.08	2.75	8.65	6.49	13.96	16°
Zudio	59109-59111	90	-	11.96	2.75	9.73	6.49	13.20	13°

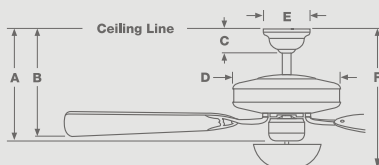

Energy measurements taken with included or exclusive blades unless noted otherwise.  
 \* Energy measurements taken with 21" basic blades

Blade Span		Weight (lb.)	Min. Ceiling Height (ft.)	Energy Information (at High Speed)				Motor Size	Fan Control
Long	Short			Speed (rpm)	Airflow (cfm)	Electricity Use (watts)	Airflow Efficiency (cfm/watt)		
60"	34"		8	145	6,191	87.70	70.60	188mm x 20mm	4 speed wall control
60"		27	8	142	6,864	82.00	84.00	188mm x 20mm	4 speed pullchain
60"	54"		8	146	7,001	85.00	82.37	188mm x 20mm	4 speed pullchain
60"		29	8	127	6,369	88.00	72.00	188mm x 20mm	4 speed wall control
44"		28	8	265	3,784	68.10	55.60	188mm x 20mm	4 speed wall control
52"		28	8	171	3,859	68.90	55.90	188mm x 20mm	4 speed wall control
30"		40	9	350	2,855	56.20	50.79	172mm x 12mm	4 speed wall control
58"	52"	26	8	168	7,375	84.00	88.00	188mm x 20mm	4 speed wall control
54"		19	8	186	6,675	32.40	206.00	165 DC	DC 6 speed
54"		27	8	214	6,393	89.30	71.59	188mm x 20mm	4 speed wall control
58"	52"	26	8	145	7,264	91.00	80.00	188mm x 20mm	4 speed pullchain
58"	52"	18	8	153	6,178	111.30	55.51	XLP-2000 - 28mm	4 speed wall control
64"		40	9	158	7,374	88.00	83.70	188mm x 20mm	4 speed wall control
52"		25	8	210	5,549	82.20	67.50	172mm x 20mm	4 speed remote
60"		18	8	180	6,916	87.20	79.32	188mm x 20mm	4 speed wall control
54"		34	8	184	6,565	90.00	73.00	188mm x 20mm	4 speed wall control
54"		31	8	177	6,142	32.00	190.00	165 DC	DC 6 speed
54"		28	8		6,142	32.00	190.00	165 DC	DC 6 speed
60"		24	8	167	6,684	32.00	209.50	165 DC	DC 6 speed
52"		30	8	210	6,233	81.40	76.60	172mm x 20mm	4 speed wall control
52"		23	9	183	6,168	75.00	82.40	172mm x 18mm	4 speed pullchain
60"		25	9	140	6,709	78.00	86.10	172mm x 18mm	4 speed wall control
54"		19	8	218	7,010	86.00	82.00	172mm x 20mm	4 speed wall control
52"		26	8	107	6,424	81.00	79.00	172mm x 20mm	4 speed pullchain
52"		30	8	212	6,503	84.50	77.00	172mm x 20mm	4 speed wall control
44"		24	8	251	4,159	56.70	73.34	172mm x 12mm	4 speed remote
54"		25	8	241	5,987	78.20	76.56	172mm x 20mm	4 speed remote
54"		23	8	220	6,250	122.00	51.00	XLP-2000 - 28mm	I•T3 W-85
31"		16	8	289	3,055	63.50	48.10	172mm x 12mm	4 speed pullchain
54"		26	8	170	6,692	84.40	79.30	172mm x 20mm	4 speed wall control
44"		18	8	268	4,527	60.80	74.50	172mm x 12mm	4 speed remote
52"		25	8	198	5,079	65.10	78.00	172mm x 12mm	4 speed remote
56"		27	8	185	6,468	85.10	76.00	188mm x 20mm	4 speed wall control

Technology:  
 I•T = Intelli-Touch  
 4-S = Four Speed  
 D•T = Direct-Touch  
 DC = DC 6-speed

MOTOR FINISHES



Acadia

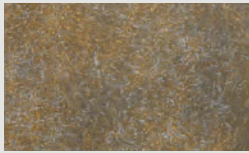

Aged Bronze



Aged Steel

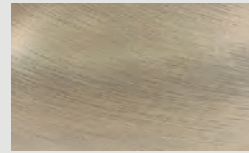

Antique Brass



Antique Pewter

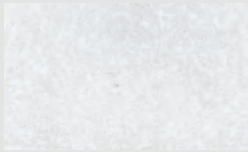

Architectural White

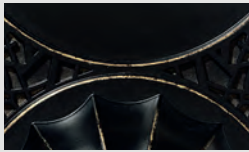

Basque Black

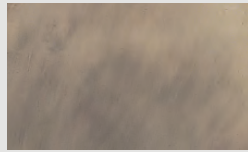

Bronze Patina

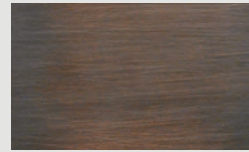

Brushed Cocoa



Brushed Nickel



Brushed Slate

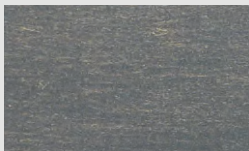

Bouillon Black

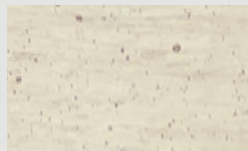

Burnished Creme

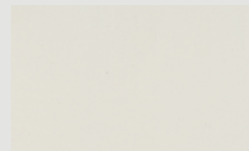

Cottage White

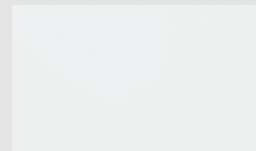

Fresh White



Galvanized Steel

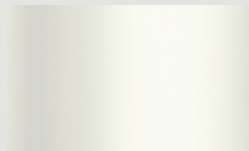

Granite

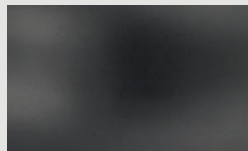

Graphite



Industrial Rust

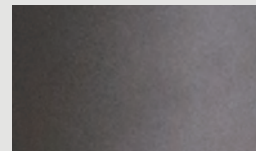

Maiden Bronze

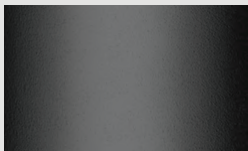

Matte Black

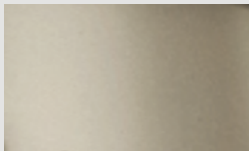

Metallic Birch

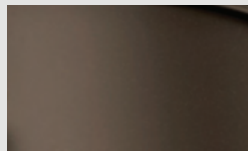

Metallic Chocolate

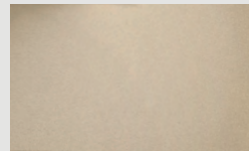

Metallic SunSand

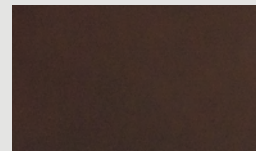

Onyx Bengal

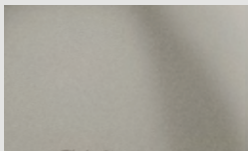

Pewter

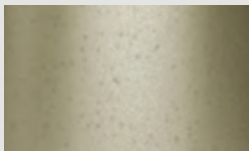

Pewter Revival

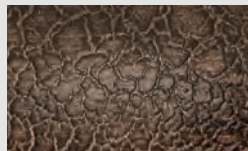

Provence Crackle

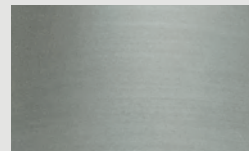

Satin Nickel



Snow White

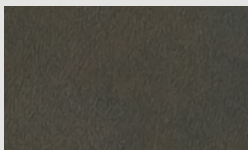

Tahoe

INDEX IN NUMERICAL ORDER

MODEL #	DESCRIPTION	PAGE
53187, 53188	Durant 44"	94
53194, 53195	Fordham	40
54000-54002	Ainsworth 54"	33
54005-54007	Ainsworth Gallery 54"	35
54010, 54011	Compass Point	25 and 108
54019-54021	Concentra	38
54022-54025	Concentra Gallery	39
54028-54030	Capistrano	22 and 106
54031-54033	Capistrano Gallery	37
54035-54038	Utopian	58 and 120
54039-54042	Utopian Gallery	59 and 121
54080, 54081	Academy Gallery	47
54083-54085	Academy	17
54101, 54102	Durant 54" with light kit	95
54103	Durant 54"	96
54105, 54106	Caledonia	93
54116-54118	Adelaide	18
54120-54122	Areto	19
55000-55002	Ainsworth 60"	34
55005-55007	Ainsworth Gallery 60"	36
55010-55012	Charthouse	23 and 107
55015, 55016	Brescia Pullchain	21
55019, 55020	Brescia Control	20
55021-55026	Panama Pullchain	29 and 117
55027-55032	Panama Control	28 and 116
55035, 55036	Fellini	51
55051, 55052	Heathridge	55 and 113
55054-55056	Coletti	24
55058-55061	Panama Gallery	42
55063 - 55065	Crestmont	26 and 109
59018-59020	Isotope 44"	97
59021-59023	Isotope 52"	98
59059-59062	Whitman	60
59064, 59065	Tercera	81
59068-59070	Bullet	64
59076-59078	Bel Air	49
59081-59083	Trident	84
59090-59094	Stealth	76
59095-59098	Panama XLP Control	30
59105-59107	Stealth DC	77
59109-59111	Zudio	90
59113, 59114	Caneel Bay	50 and 105
59119, 59121	Riello	75
59123, 59124	Aris	63 and 103
59137, 59138	Orchid	69 and 115
59143, 59144	Stingray	79
59149, 59150	Wisp 44"	87
59151, 59152	Wisp 52"	89
59153-59155	Verse 44"	85, 99 and 122
59158-59160	Verse 54"	86, 100 and 123
59162, 59163	Glen Arbor	53
59164, 59165	Stealth DC LED	78
59167, 59168	Perseus	71 and 118
59191, 59192	Duluth 60"	67 and 110
59193, 59194	Duluth 72"	68 and 111
59195, 59196	Piston	73 and 119
59197, 59198	Correne	65
59498-59501	Tribeca 52"	82
59503-59505	Tribeca 60"	83
59510-59512	Panama DC	41
59518	Fellini DC	52
59523-59525	Wailea	44 and 124
59527-59528	Heritage	56 and 114
59532-59535	Holliston	27
59536, 59537	Holliston Gallery	57
60129 (6373Z)	Victorian	43
64395 (C18G500F)	Atria	48 and 104

INDEX IN ALPHABETICAL ORDER

MODEL #	DESCRIPTION	PAGE
54083-54085	Academy	17
54080, 54081	Academy Gallery	47
54116-54118	Adelaide	18
54000-54002	Ainsworth 54"	33
55000-55002	Ainsworth 60"	34
54005-54007	Ainsworth Gallery 54"	35
55005-55007	Ainsworth Gallery 60"	36
54120-54122	Areto	19
59123, 59124	Aris	63 and 103
64395 (C18G500F)	Atria	48 and 104
59076-59078	Bel Air	49
55019, 55020	Brescia Control	20
55015, 55016	Brescia Pullchain	21
59068-59070	Bullet	64
54105, 54106	Caledonia	93
59113, 59114	Caneel Bay	50 and 105
54028-54030	Capistrano	22 and 106
54031-54033	Capistrano Gallery	37
55010-55012	Charthouse	23 and 107
55054-55056	Coletti	24
54010, 54011	Compass Point	25 and 108
54019-54021	Concentra	38
54022-54025	Concentra Gallery	39
59197, 59198	Correne	65
55063-55065	Crestmont	26 and 109
59191, 59192	Duluth 60"	67 and 110
59193, 59194	Duluth 72"	68 and 111
53187, 53188	Durant 44"	94
54101, 54102	Durant 54" with light kit	95
54103	Durant 54"	96
55035, 55036	Fellini	51
59518	Fellini DC	52
53194, 53195	Fordham	40
59162, 59163	Glen Arbor	53
55051, 55052	Heathridge	55 and 113
59527-59528	Heritage	56 and 114
59532-59535	Holliston	27
59536, 59537	Holliston Gallery	57
59018-59020	Isotope 44"	97
59021-59023	Isotope 52"	98
59137, 59138	Orchid	69 and 115
55027-55032	Panama Control	28 and 116
59510-59512	Panama DC	41
55058-55061	Panama Gallery	42
55021-55026	Panama Pullchain	29 and 117
59095-59098	Panama XLP Control	30
59167, 59168	Perseus	71 and 118
59195, 59196	Piston	73 and 119
59119, 59121	Riello	75
59090-59094	Stealth	76
59105-59107	Stealth DC	77
59164, 59165	Stealth DC LED	78
59143, 59144	Stingray	79
59064, 59065	Tercera	81
59498-59501	Tribeca 52"	82
59503-59505	Tribeca 60"	83
59081-59083	Trident	84
54035-54038	Utopian	58 and 120
54039-54042	Utopian Gallery	59 and 121
59153-59155	Verse 44"	85, 99 and 122
59158-59160	Verse 54"	86, 100 and 123
60129 (6373Z)	Victorian	43
59523-59525	Wailea	44 and 124
59059-59062	Whitman	60
59149, 59150	Wisp 44"	87
59151, 59152	Wisp 52"	89
59109-59111	Zudio	90

# DISCOVER

DESIGN TRENDS | STYLE INPIRATION | INDUSTRY NEWS



@CasablancaFanCo